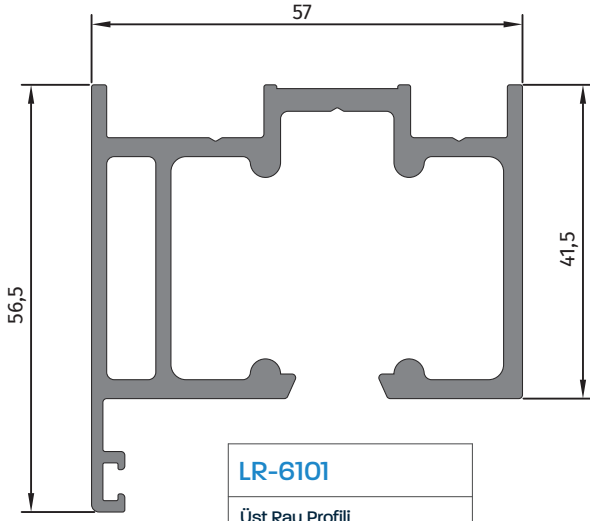
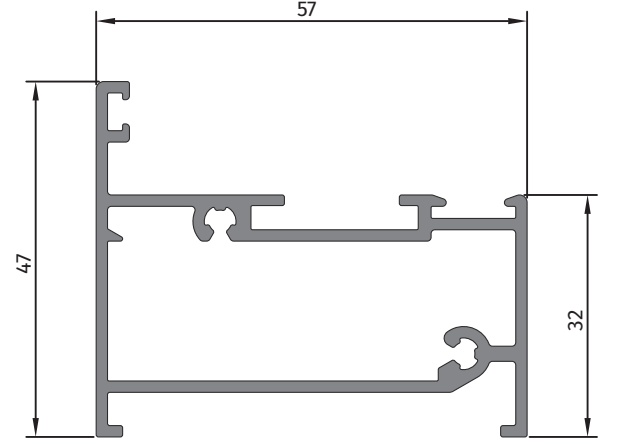

6100 KATLANIR
YALITIMSIZ SİSTEM

 **ALFORE®**

**LR-6101**

Üst Ray Profili

Ağırlık (Kg/mt.)
Weight (Kg/mt.)
1,595 Kg/mt.**LR-6102**

Yan Kasa Profili

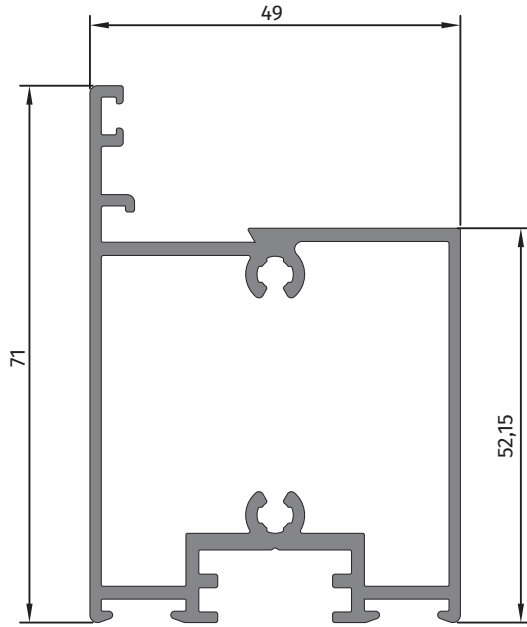
Ağırlık (Kg/mt.)
Weight (Kg/mt.)
0,990 Kg/mt.**LR-6112**

90° Kanat Profili

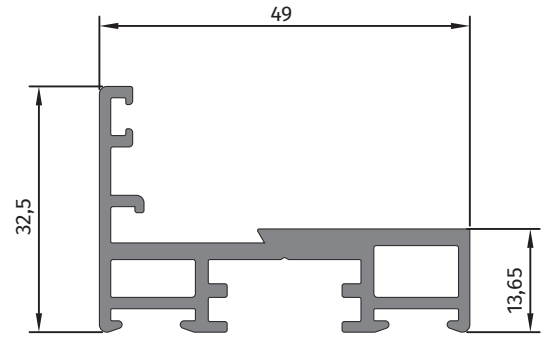
Ağırlık (Kg/mt.)
Weight (Kg/mt.)
1,302 Kg/mt.**LR-6111**

90° Kanat Profili

Ağırlık (Kg/mt.)
Weight (Kg/mt.)
0,830 Kg/mt.

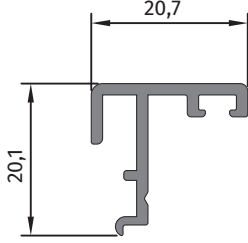
**LR-6104**

Tırnak Profili

Ağırlık (Kg/mt.)
Weight (Kg/mt.)
0,221 Kg/mt.

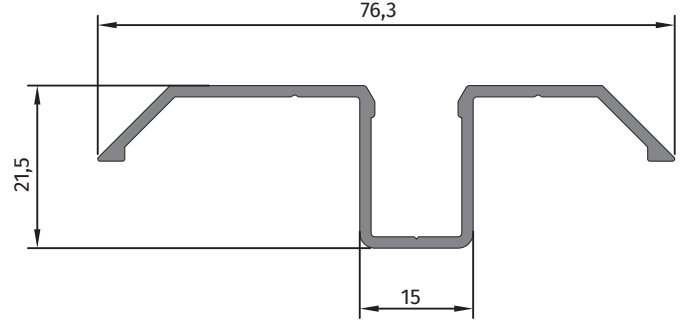
**LR-6105**

Alt Klavuz Profili

Ağırlık (Kg/mt.)
Weight (Kg/mt.)
0,510 Kg/mt.

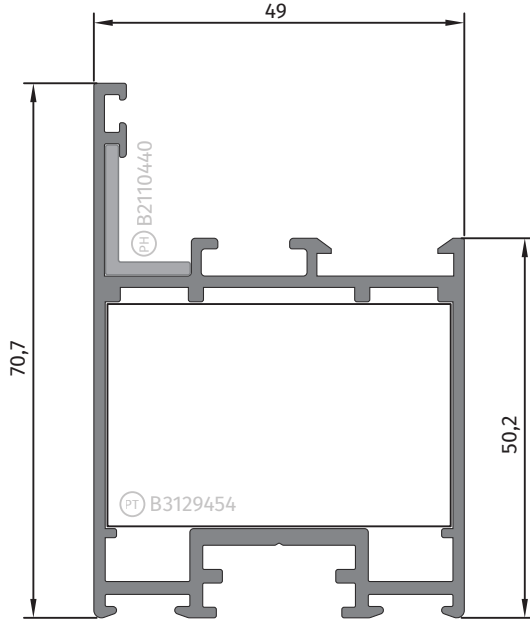
**LR-6103**

45° Kanat Profili

Ağırlık (Kg/mt.)
Weight (Kg/mt.)
1,210 Kg/mt.

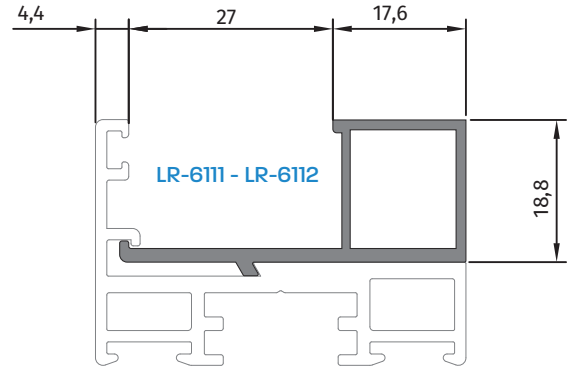
**LR-6111 - LR-6112****LR-6131**

Cam Çıta Profili

Ağırlık (Kg/mt.)
Weight (Kg/mt.)
0,405 Kg/mt.

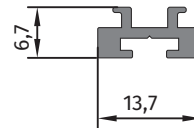
**LR-6110**

Alt Fital Profili

Ağırlık (Kg/mt.)
Weight (Kg/mt.)
0,126 Kg/mt.

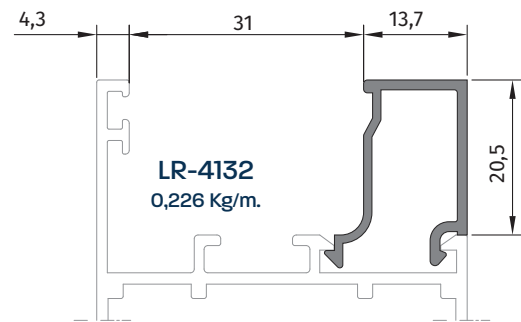
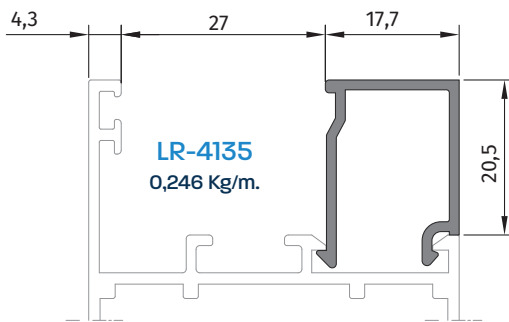
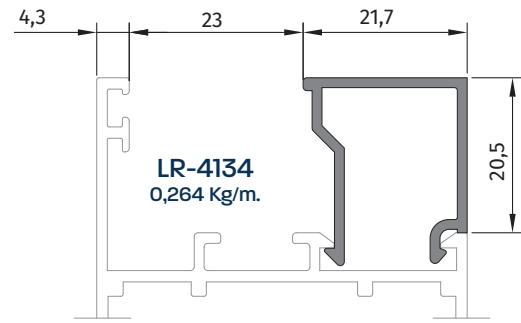
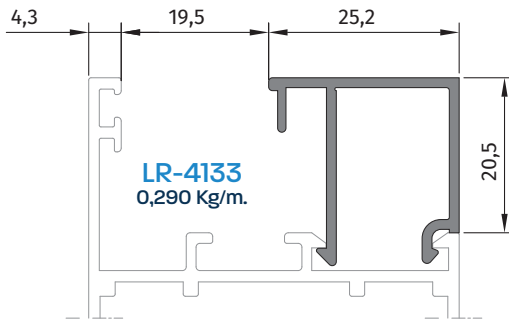
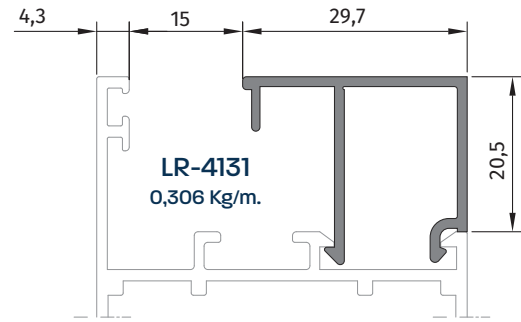
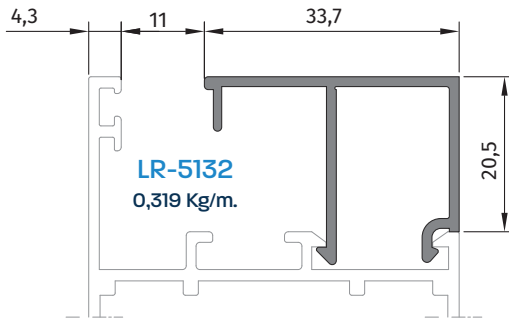

LR 6100 YALITIMSIZ KATLANIR SİSTEM
UNINSULATED BI-FOLD SYSTEM

45° KANAT AÇILIM TİPLERİ
45° TYPES OF OPENING

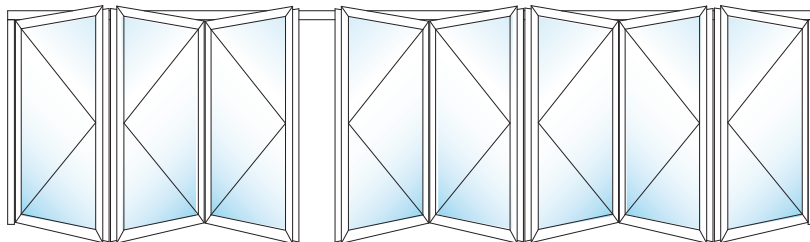
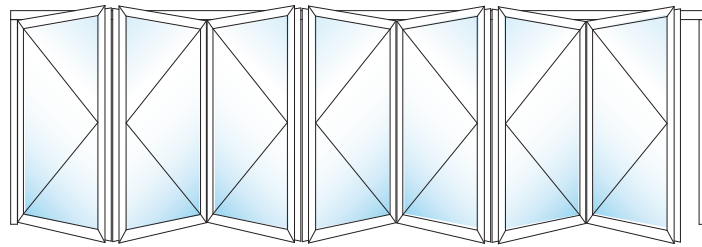
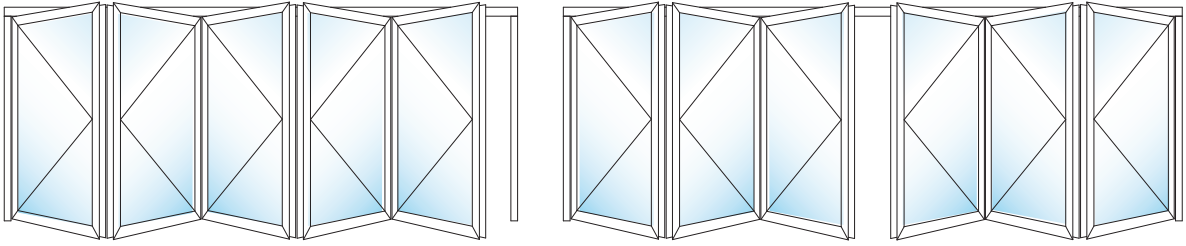
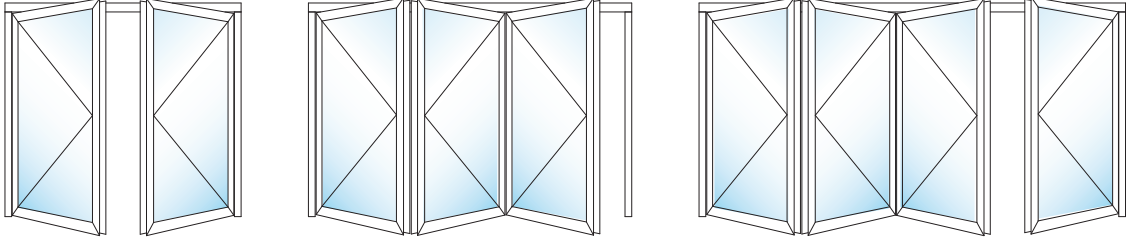

1 Detay
Detail

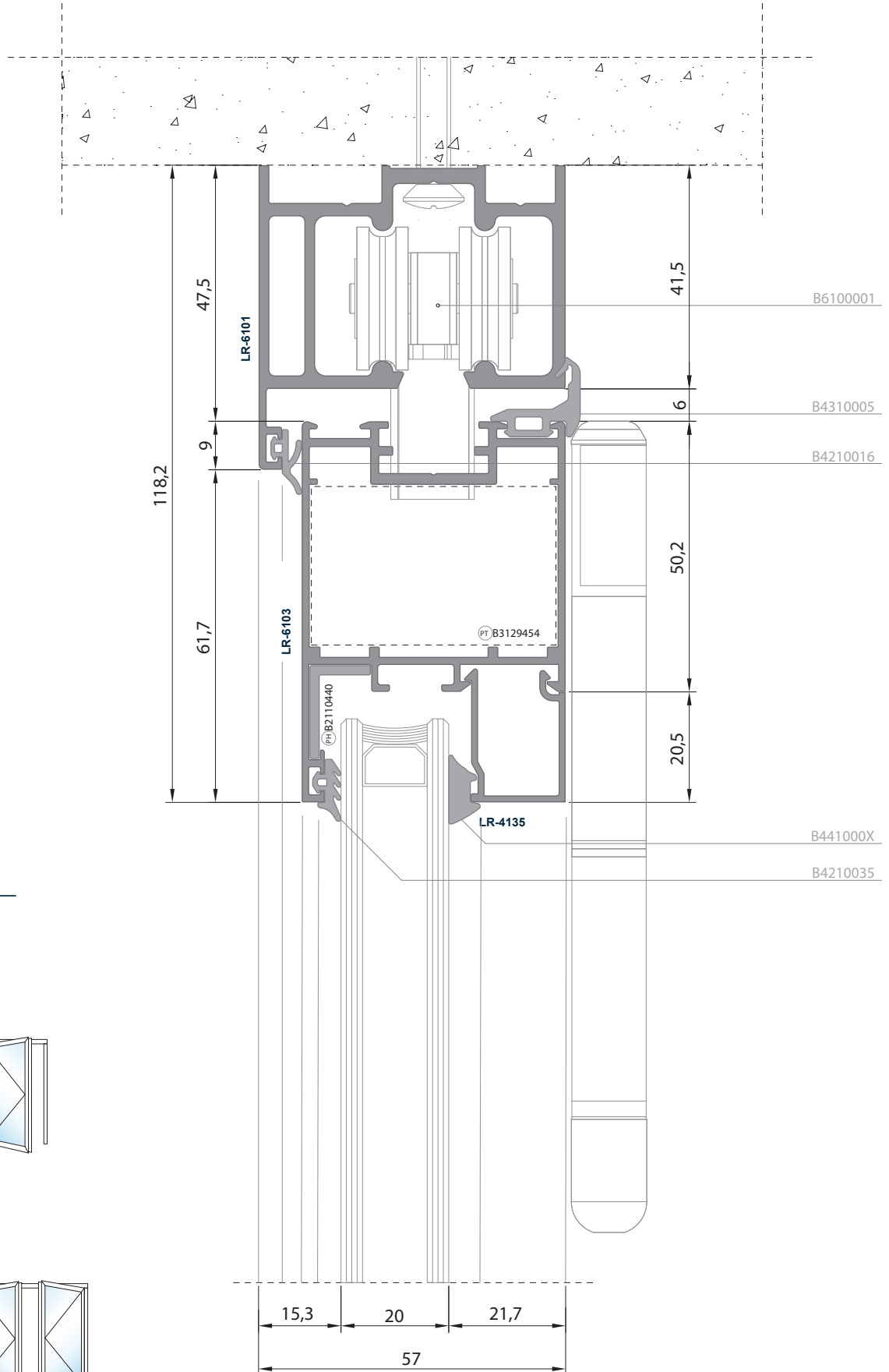
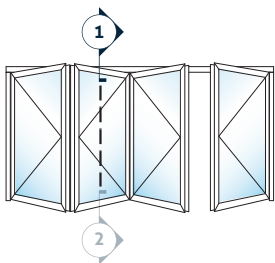
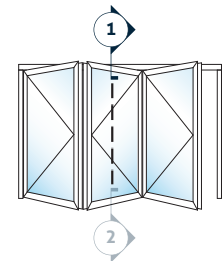

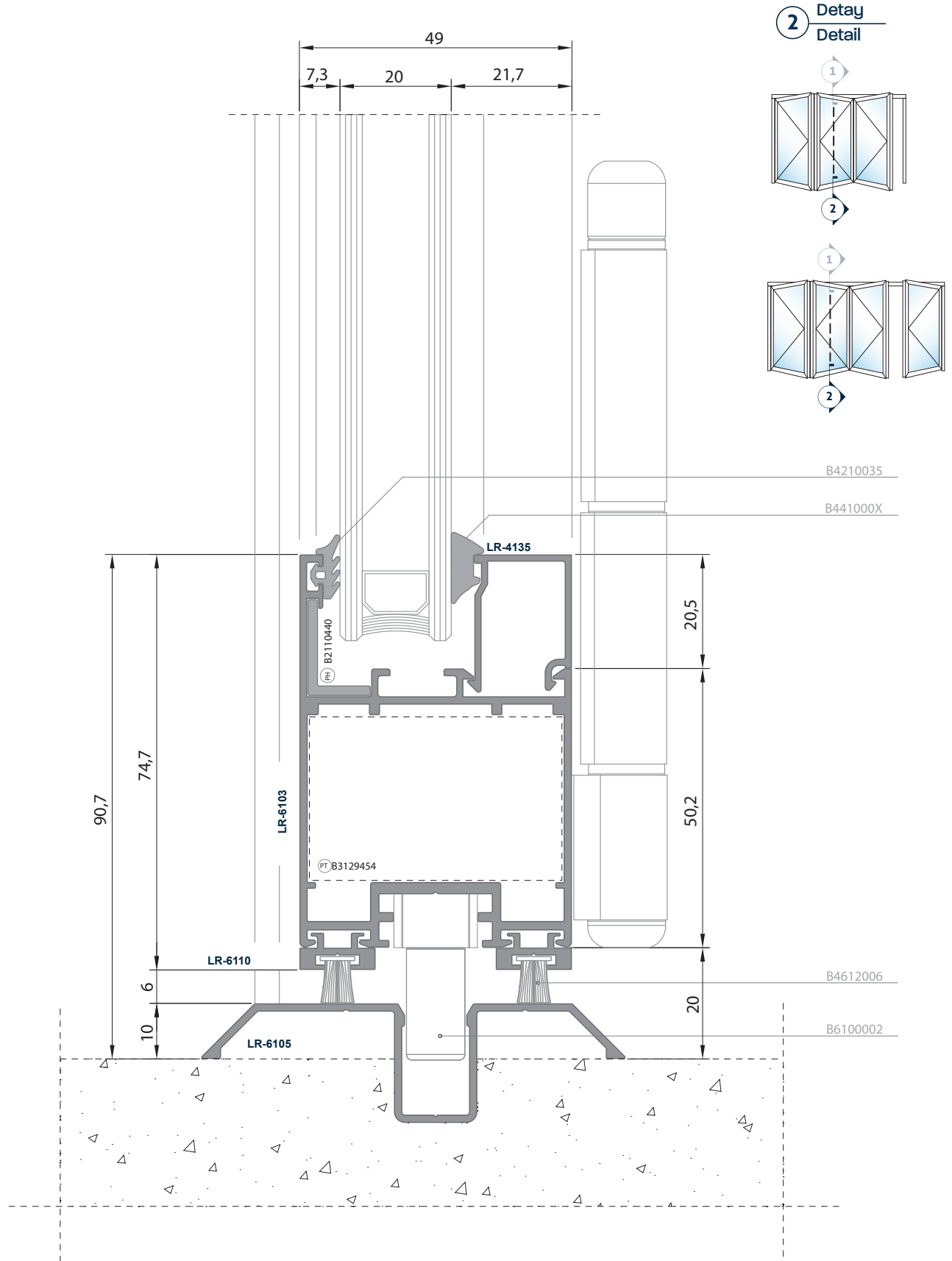

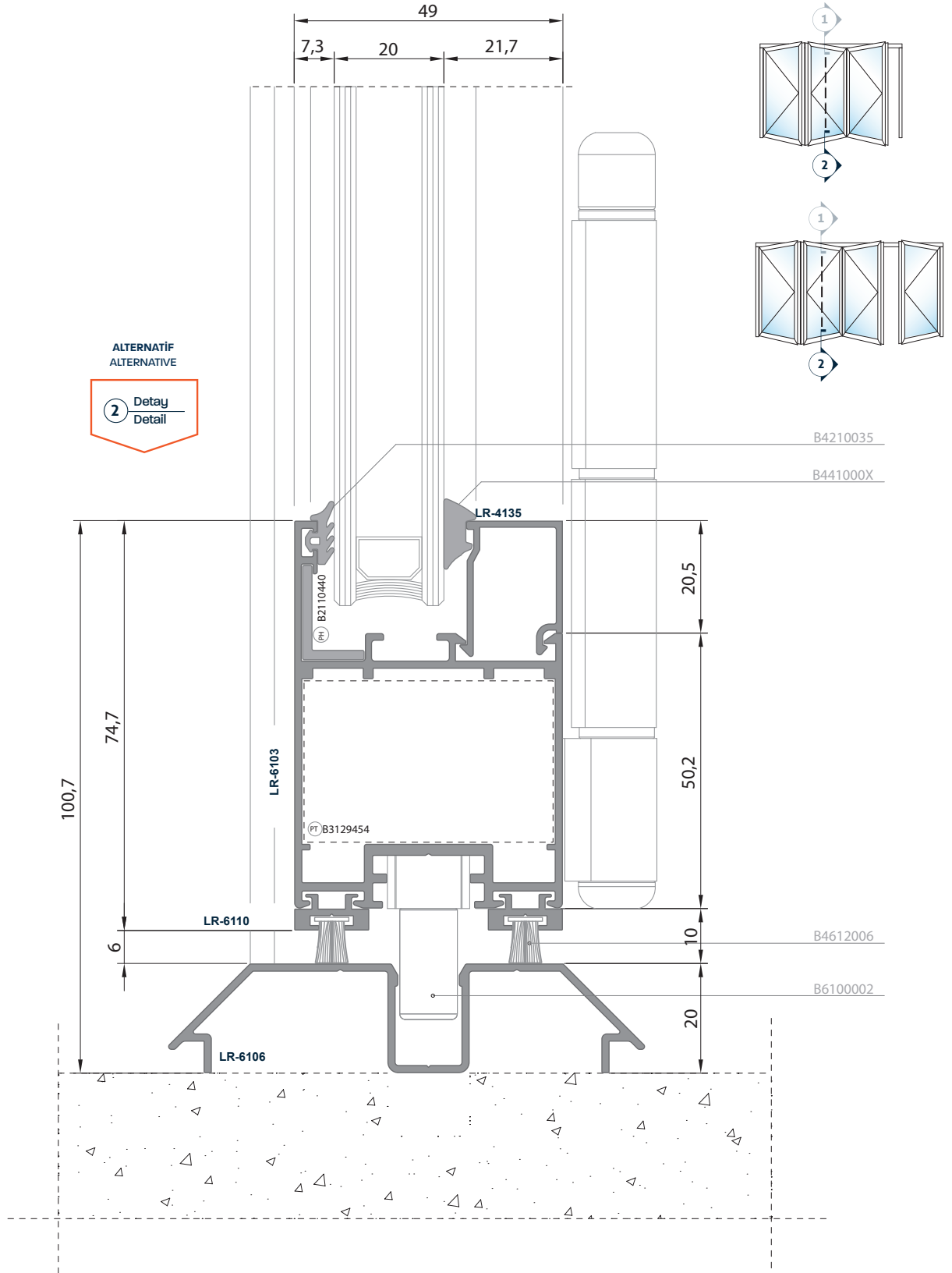

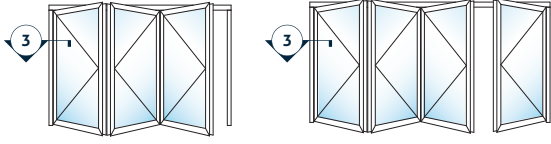

3 Detay
Detail

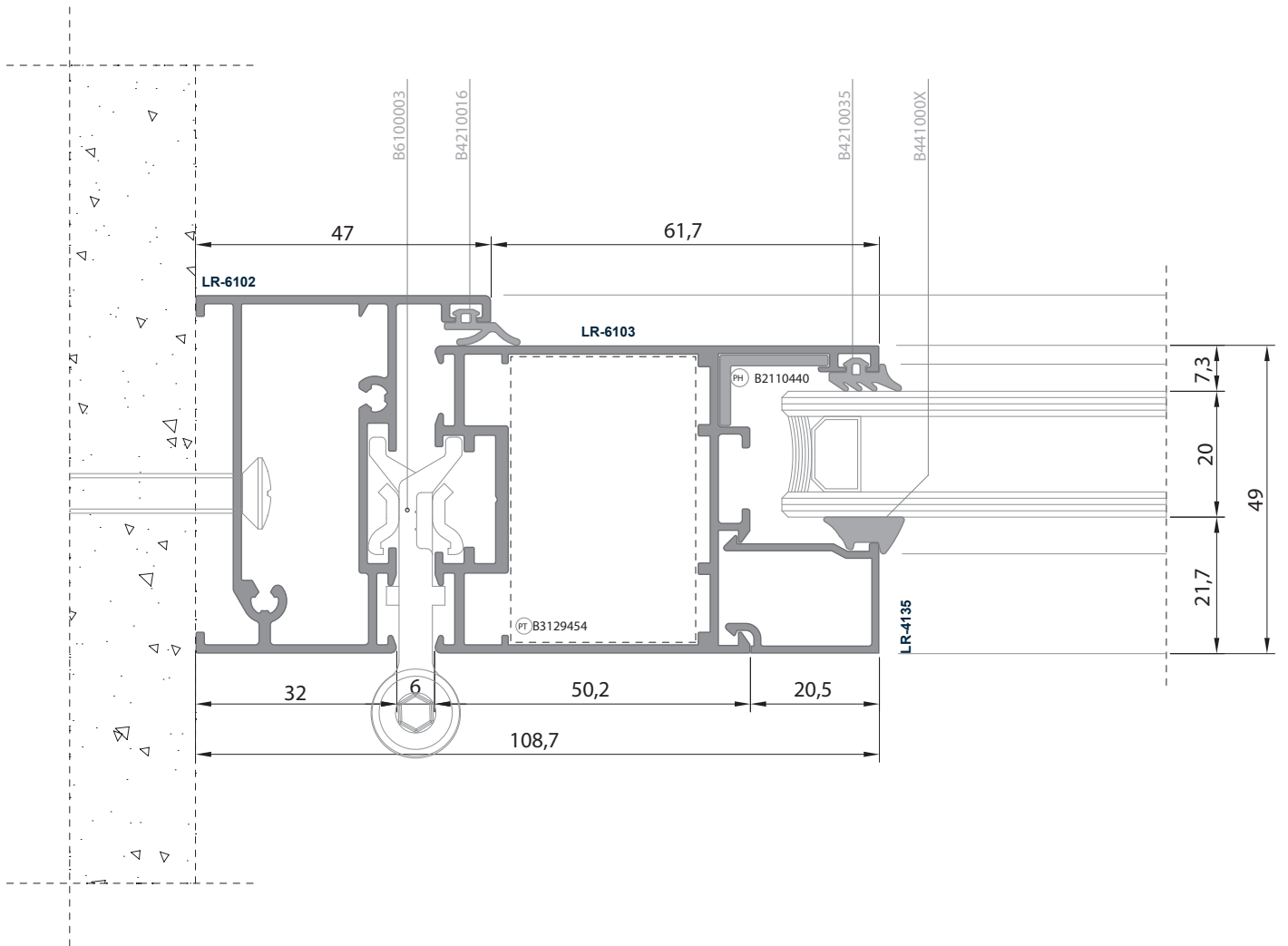

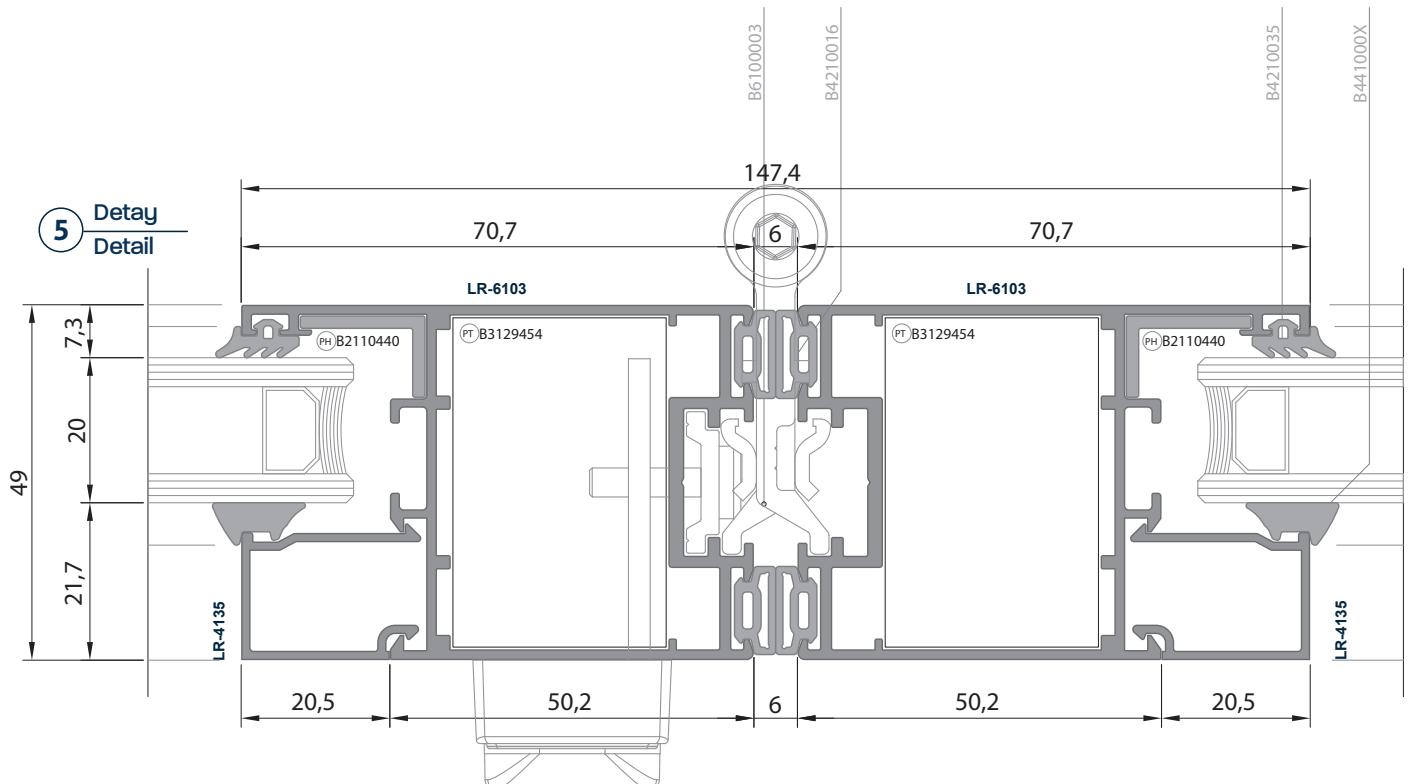
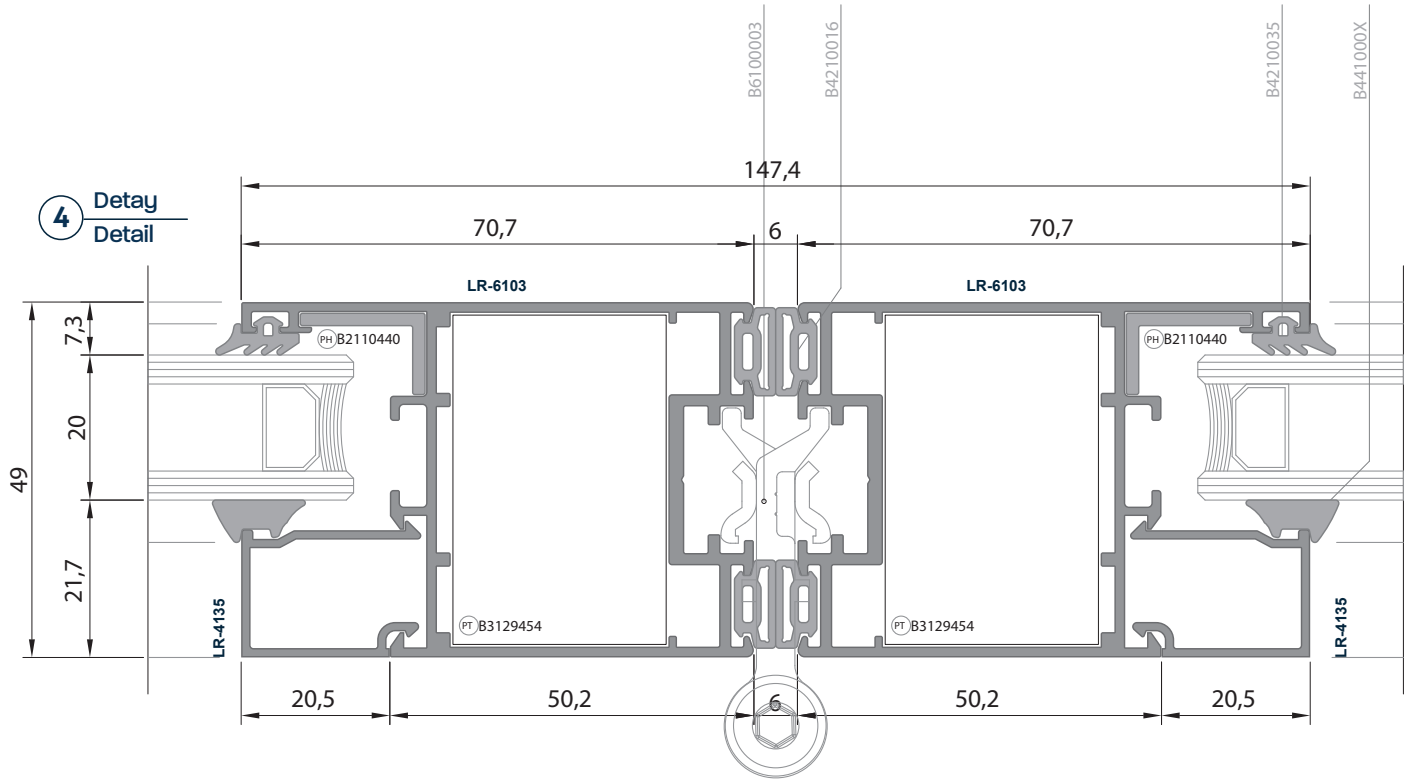
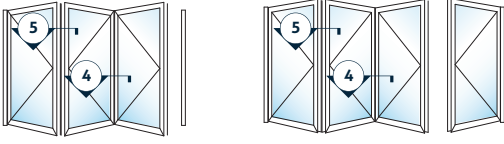

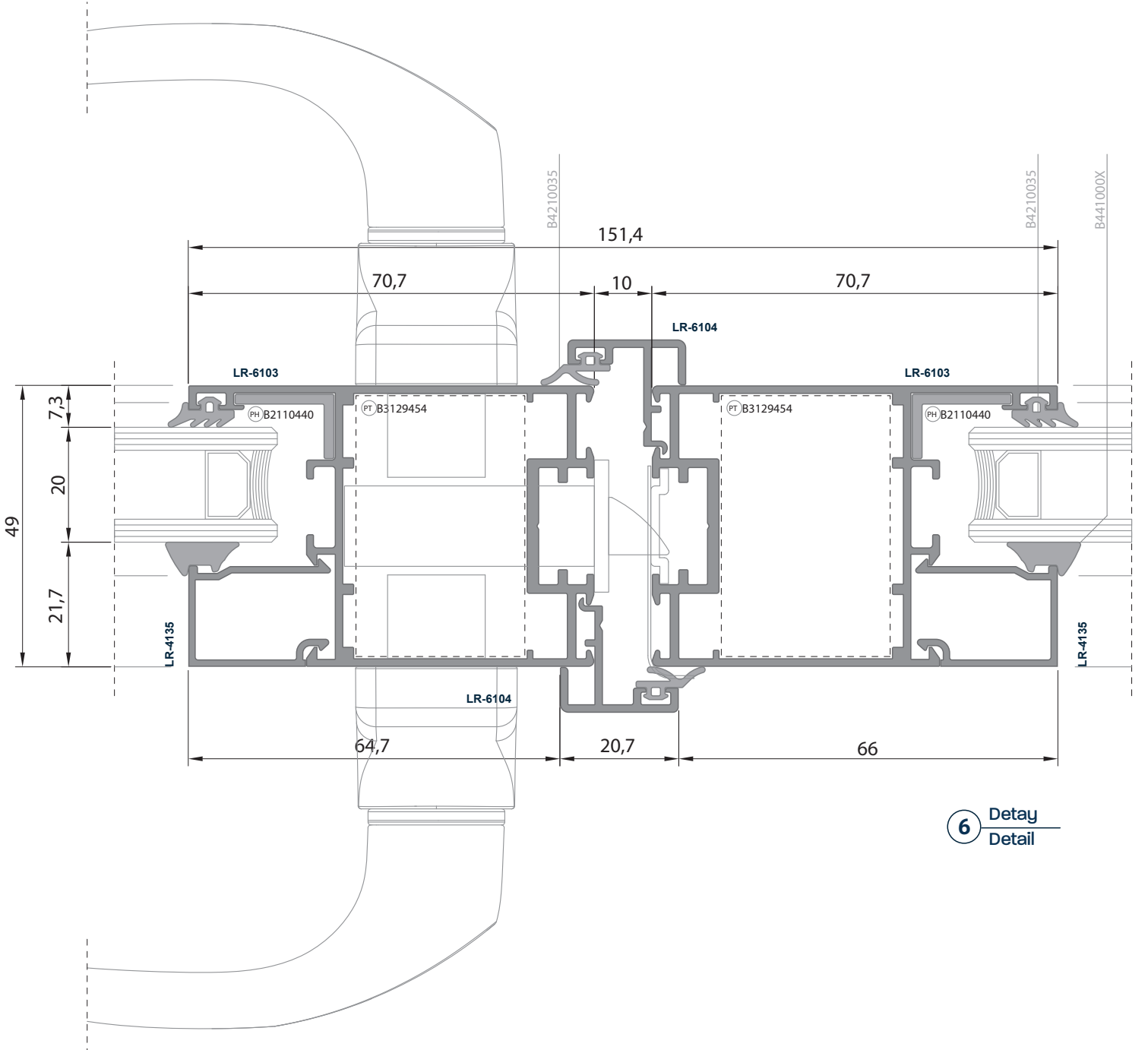
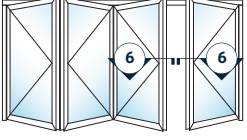

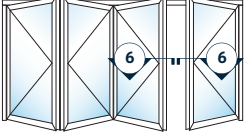

ALTERNATİF
ALTERNATIVE

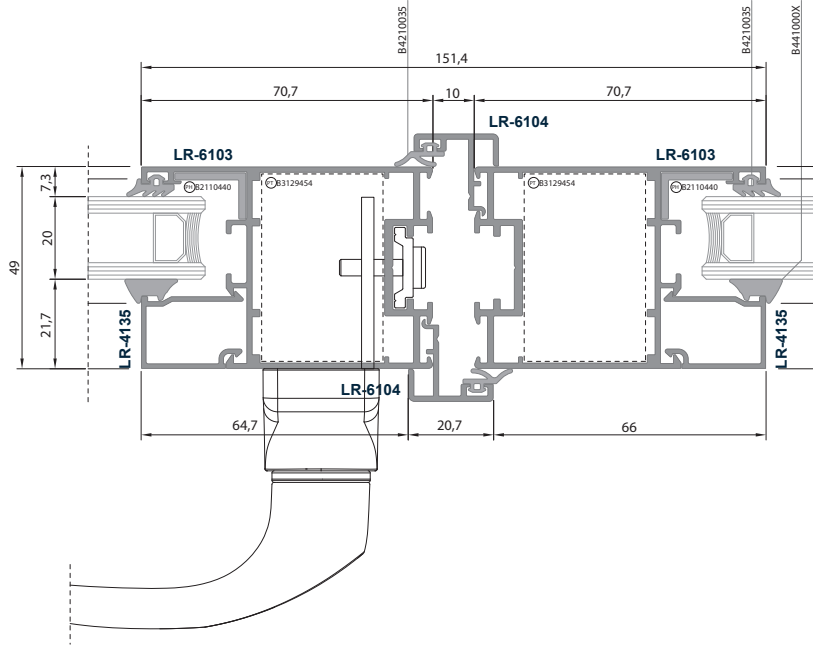

ALTERNATİF
ALTERNATIVE

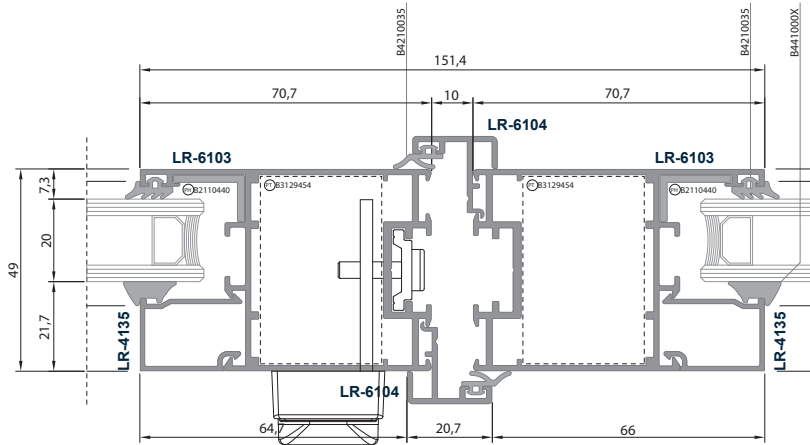

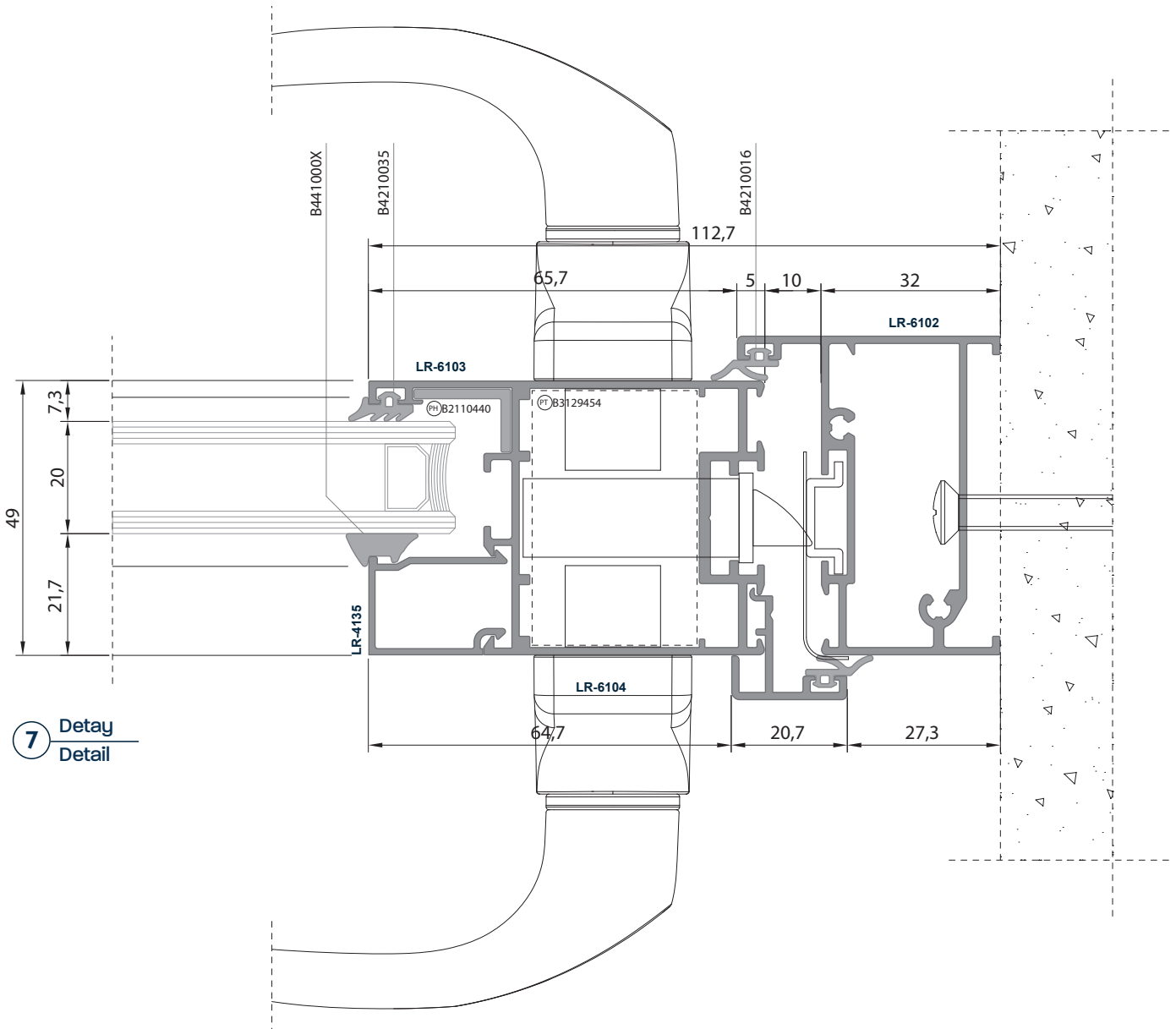
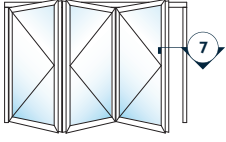

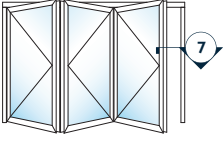

ALTERNATİF
ALTERNATIVE

7 Detay
Detail

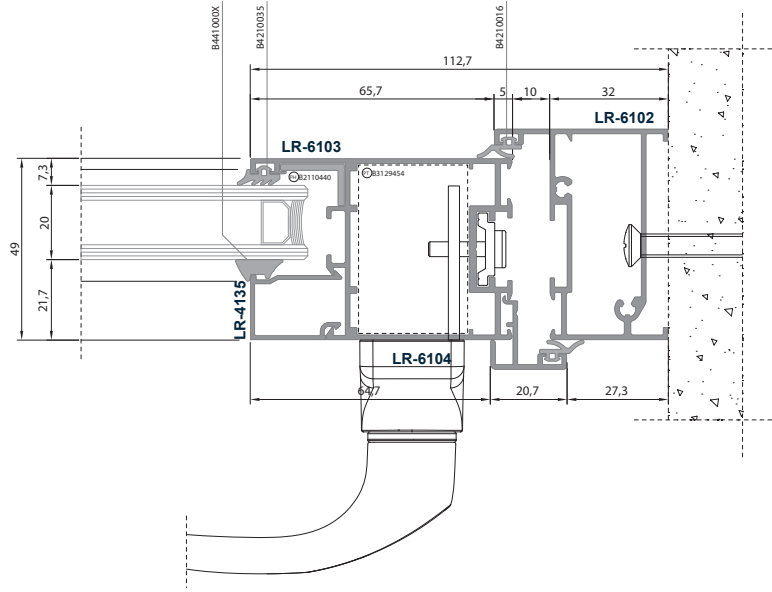

ALTERNATİF
ALTERNATIVE

7 Detay
Detail

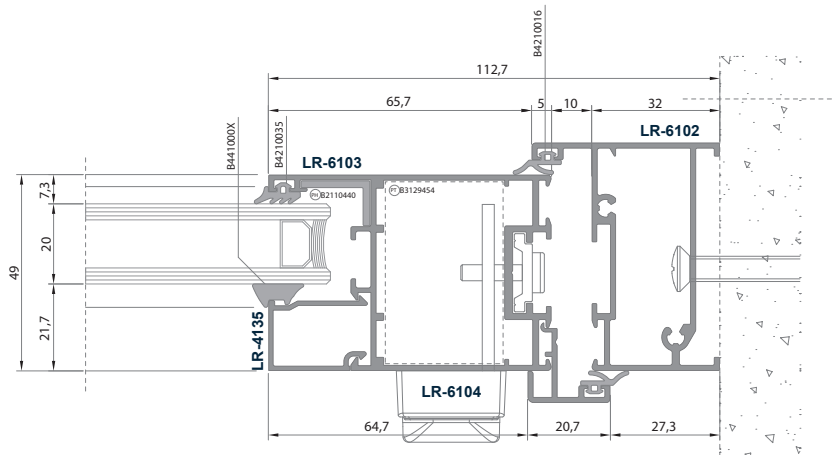

LR 6100 YALITIMSIZ KATLANIR SİSTEM
UNINSULATED BI-FOLD SYSTEM

90° KANAT AÇILIM TİPLERİ
90° TYPES OF OPENING

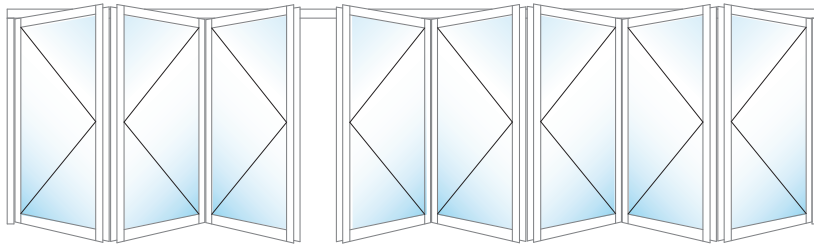
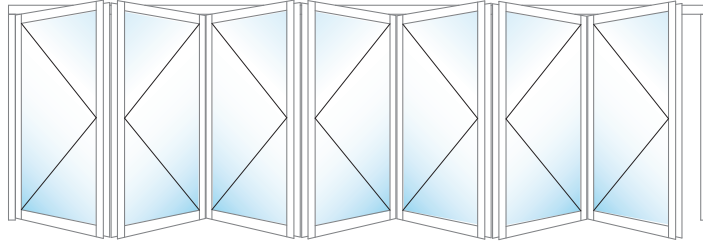
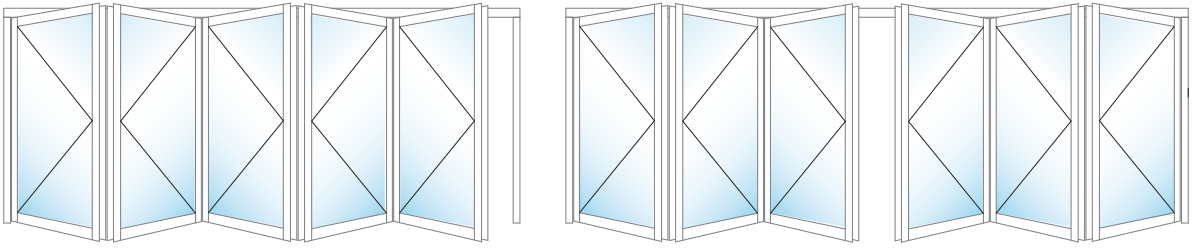
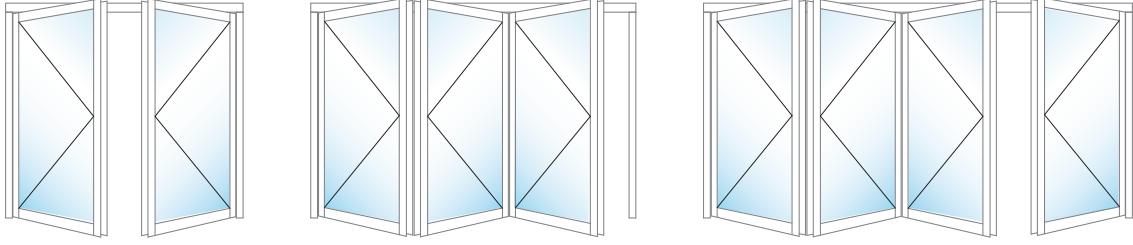

1 Detay
Detail

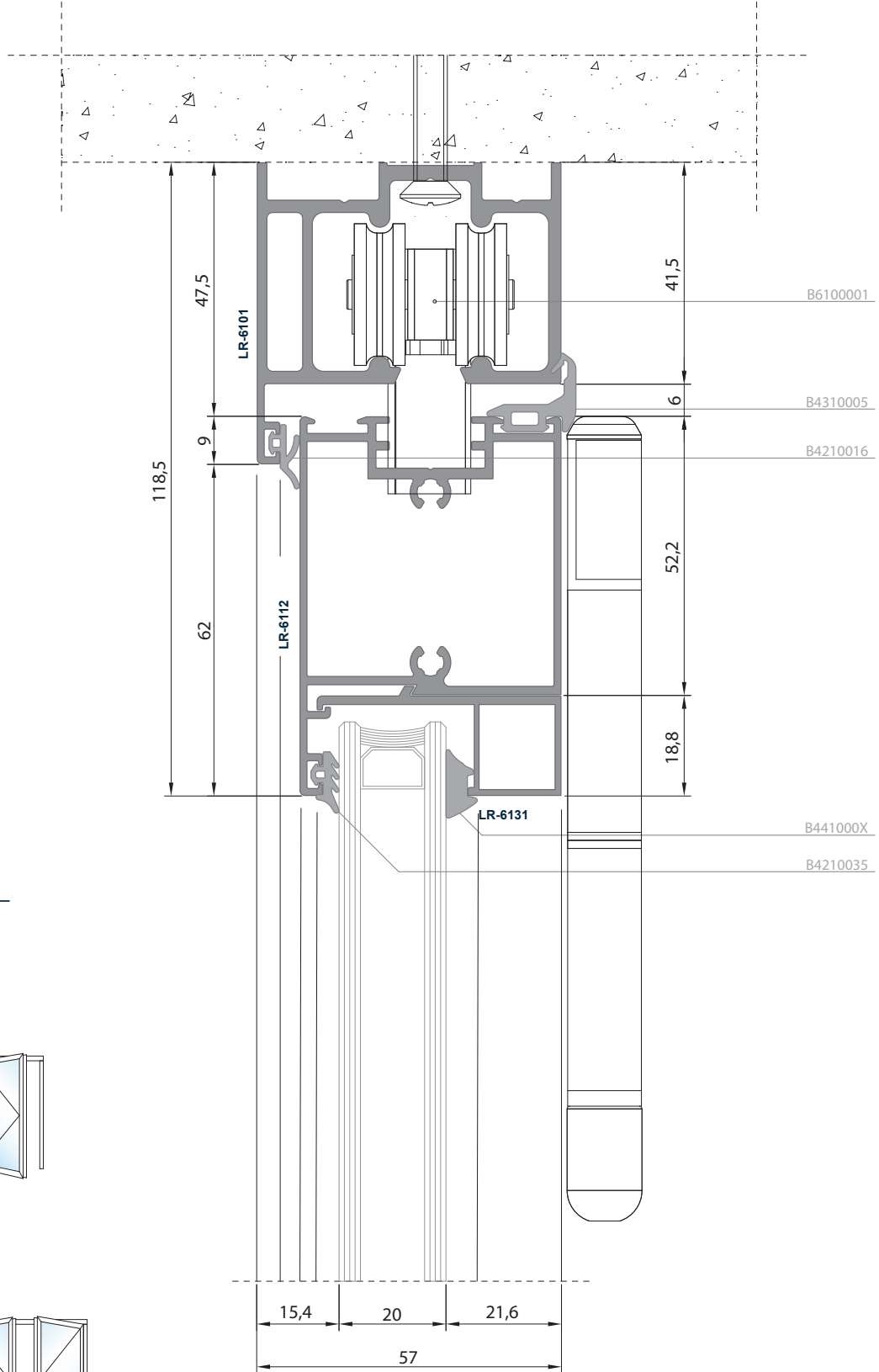
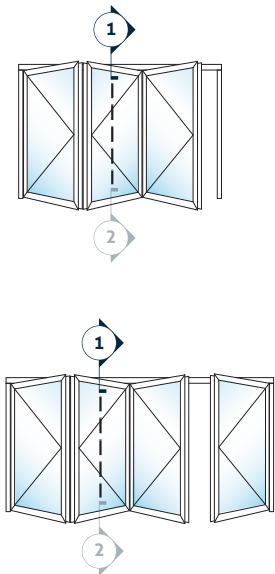

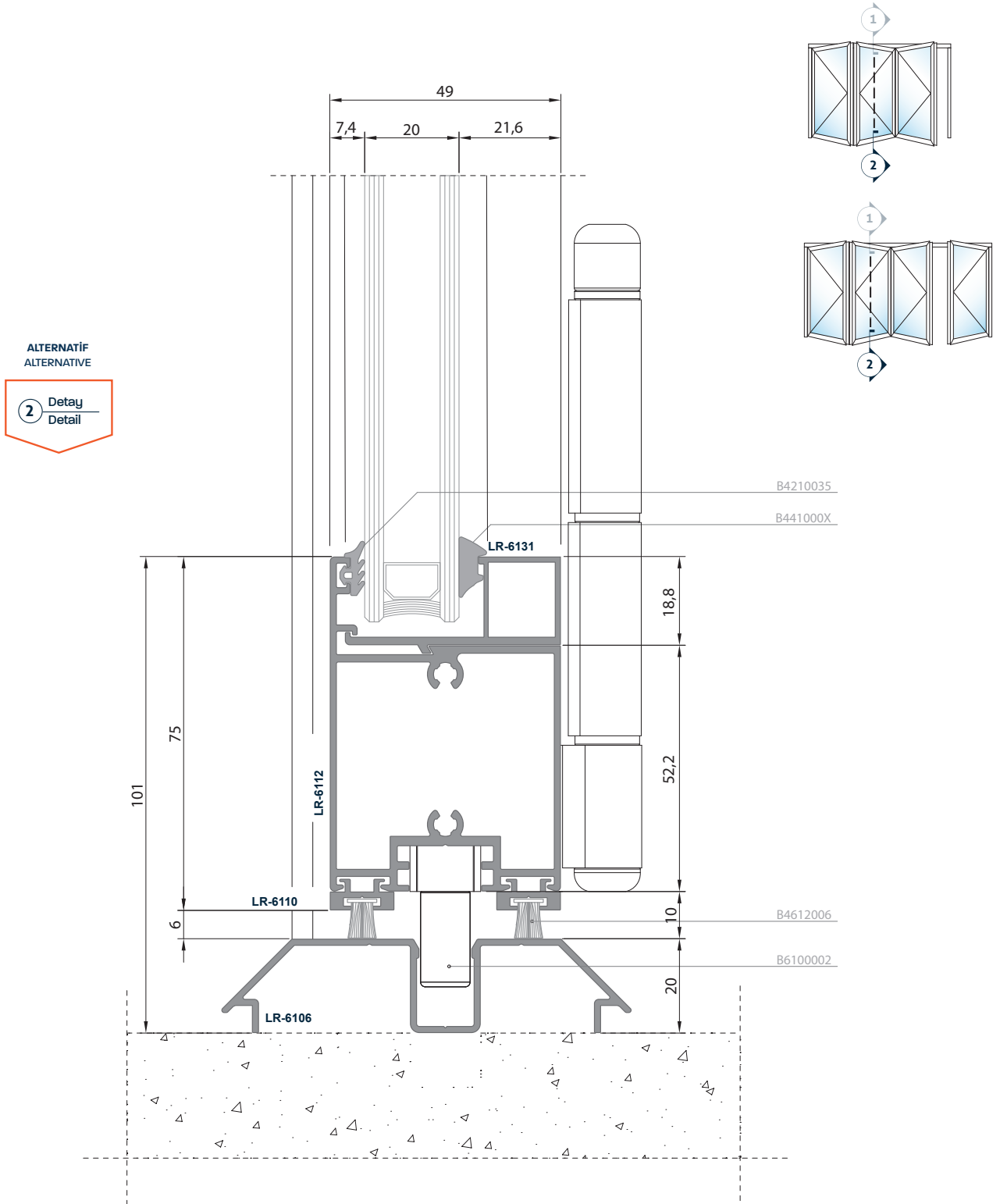

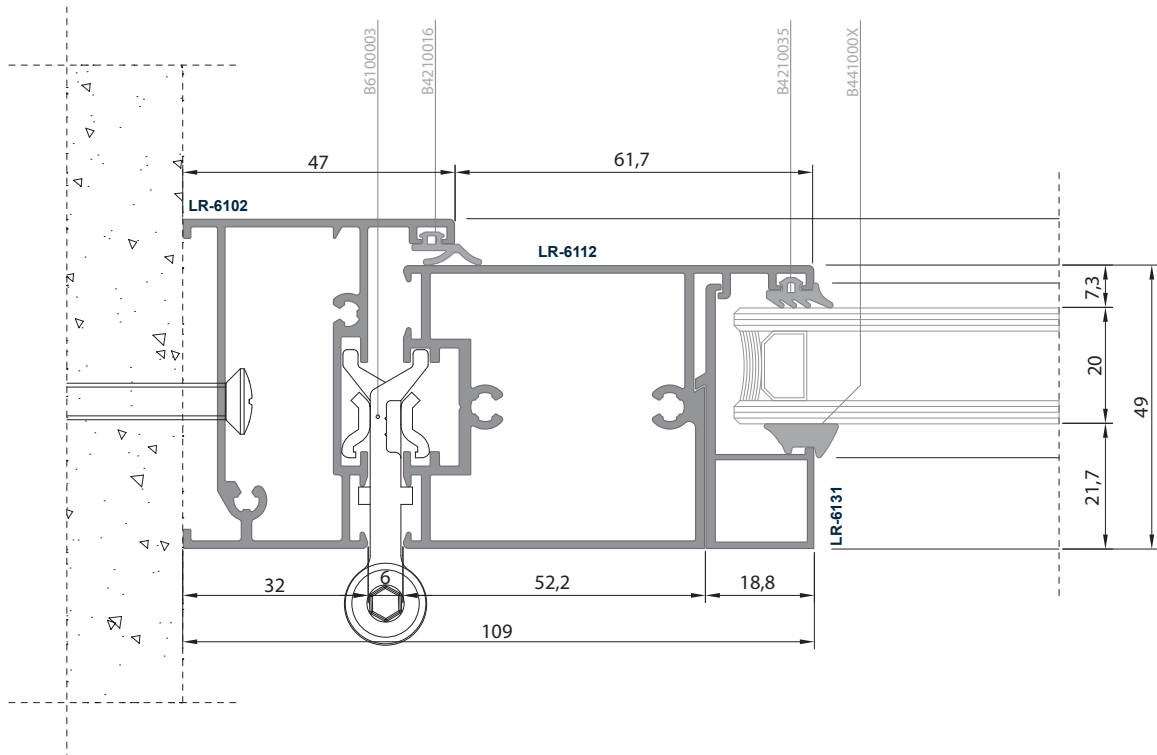
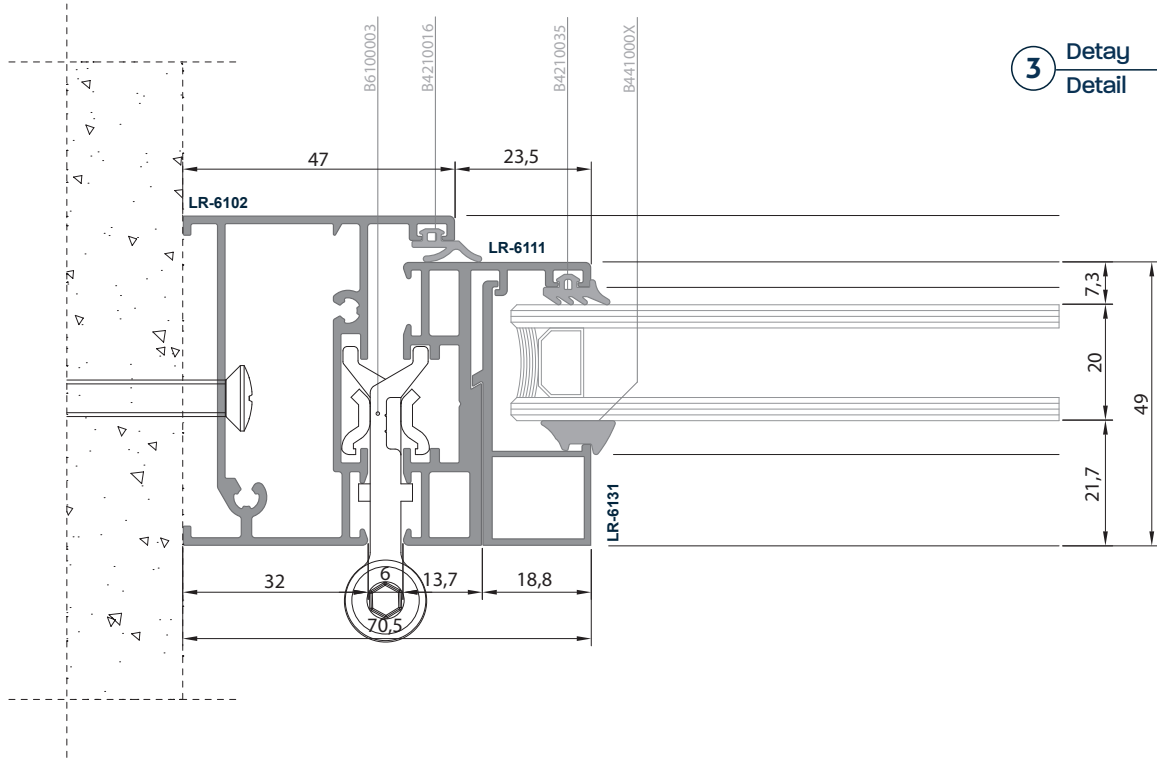
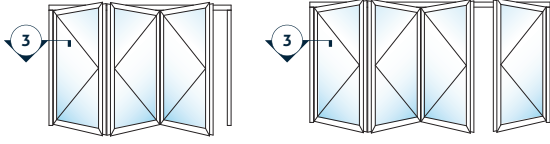

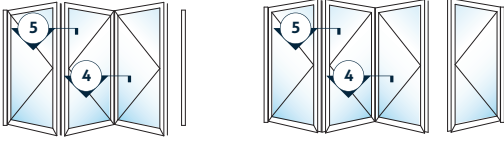

4 Detay
Detail

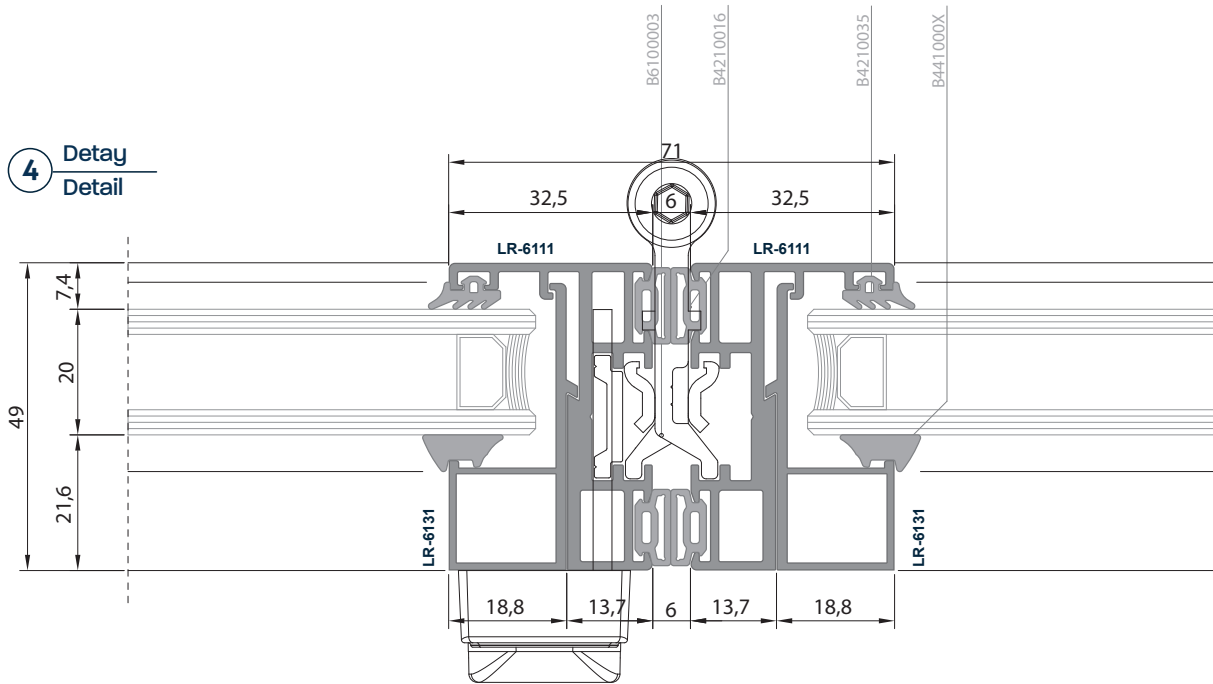

5 Detay
Detail

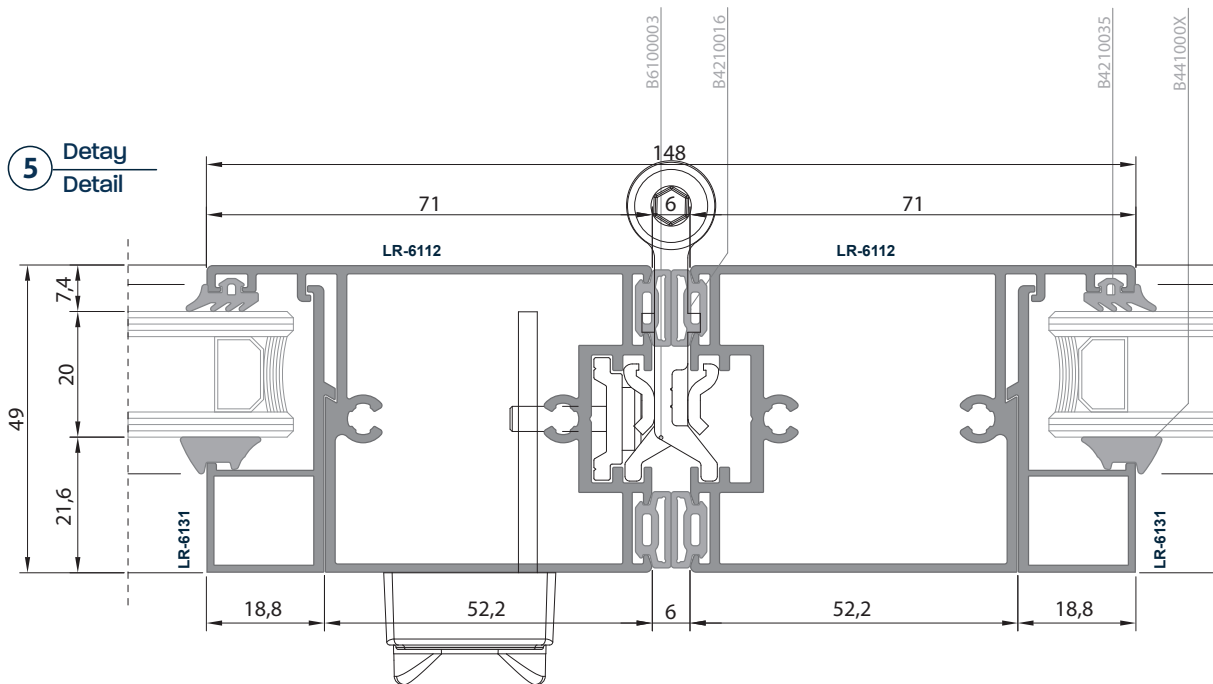

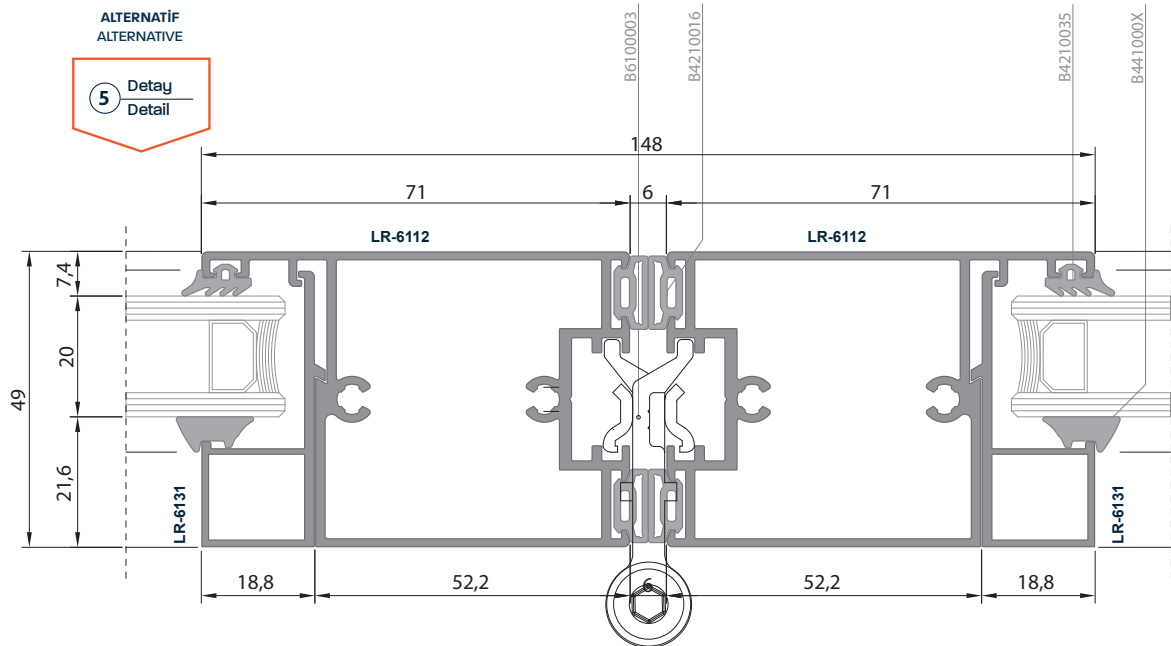
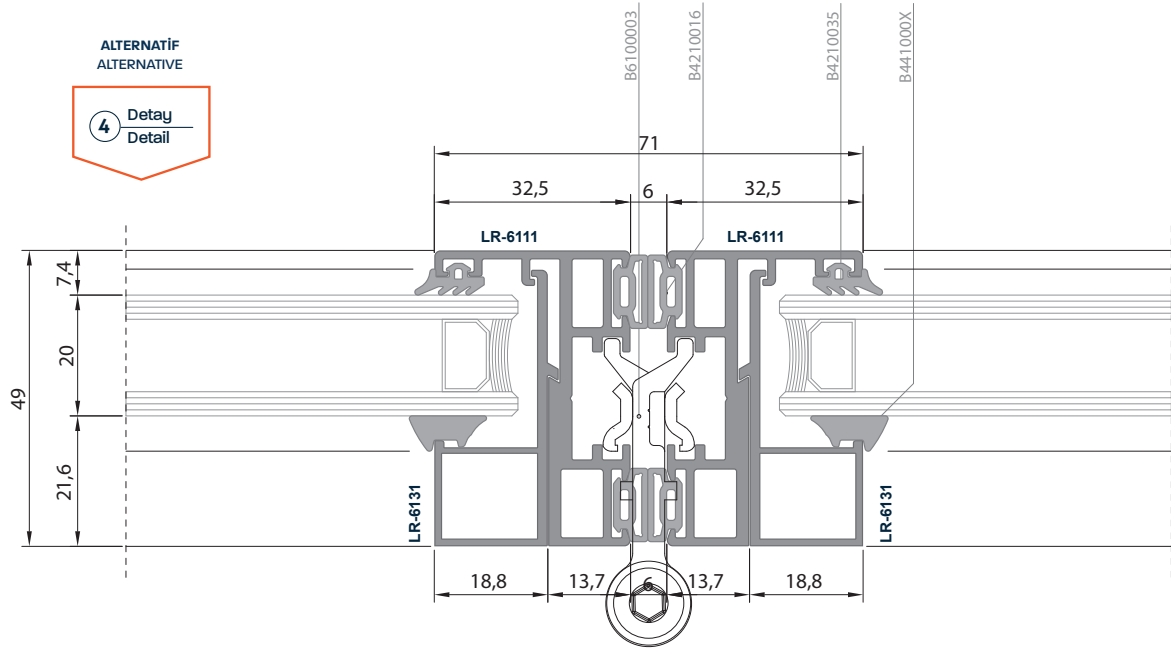
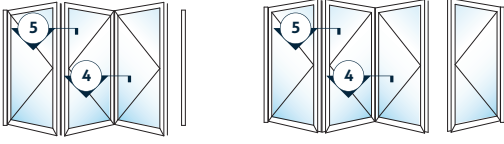

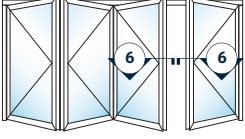

6 Detay
Detail

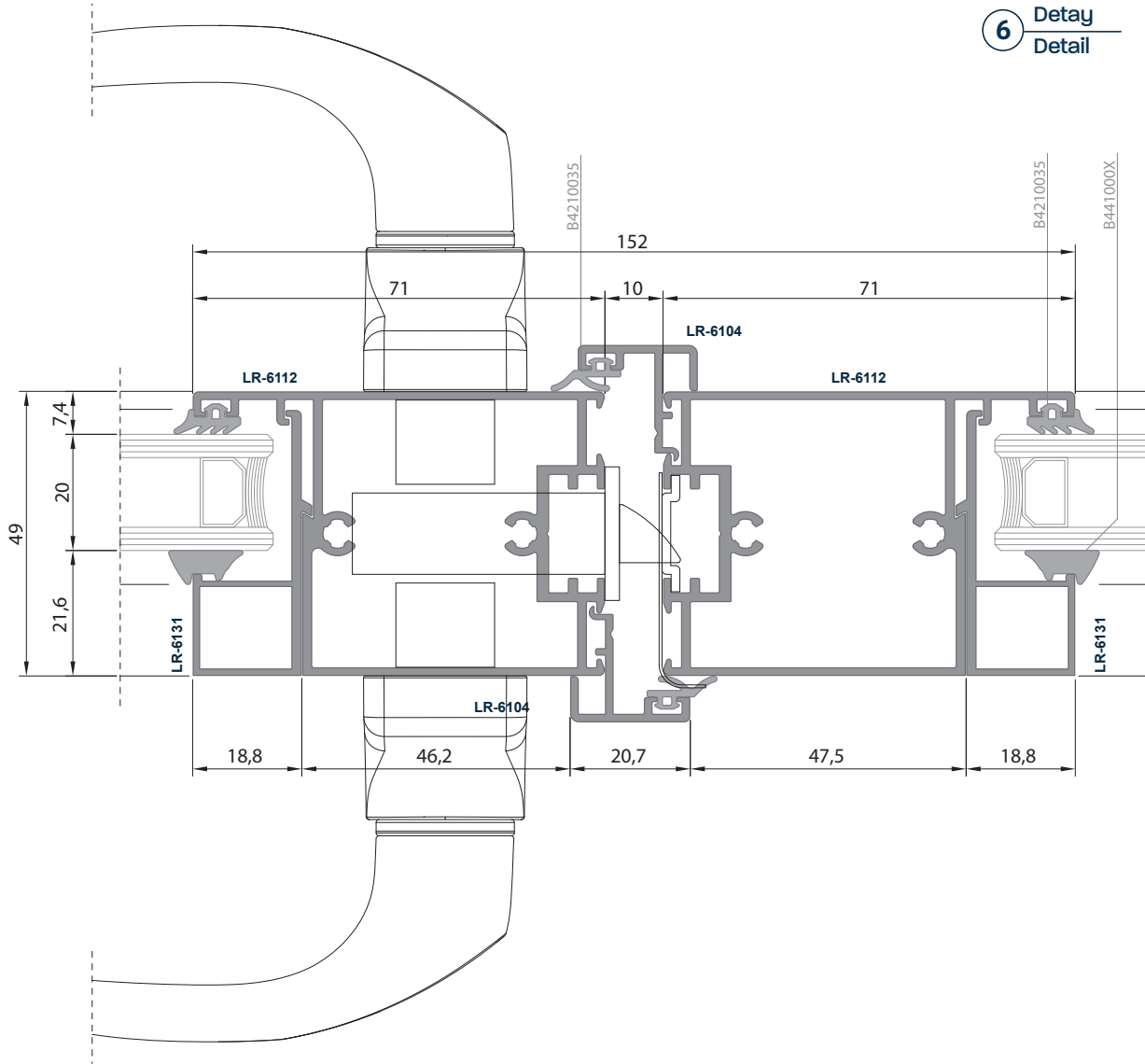

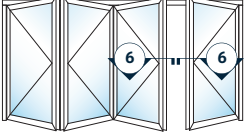

ALTERNATİF
ALTERNATIVE

6 Detay
Detail

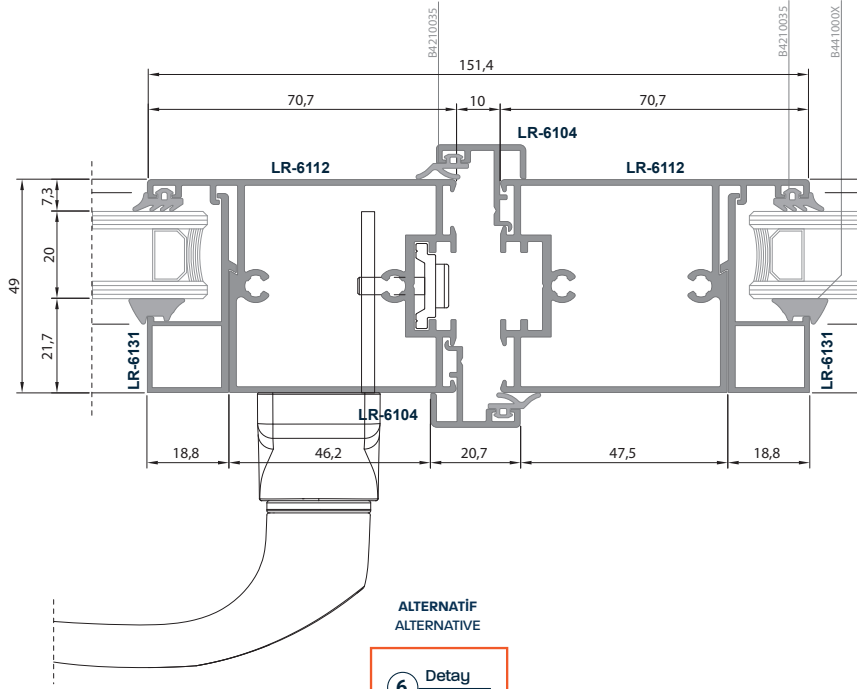

ALTERNATİF
ALTERNATIVE

6 Detay
Detail

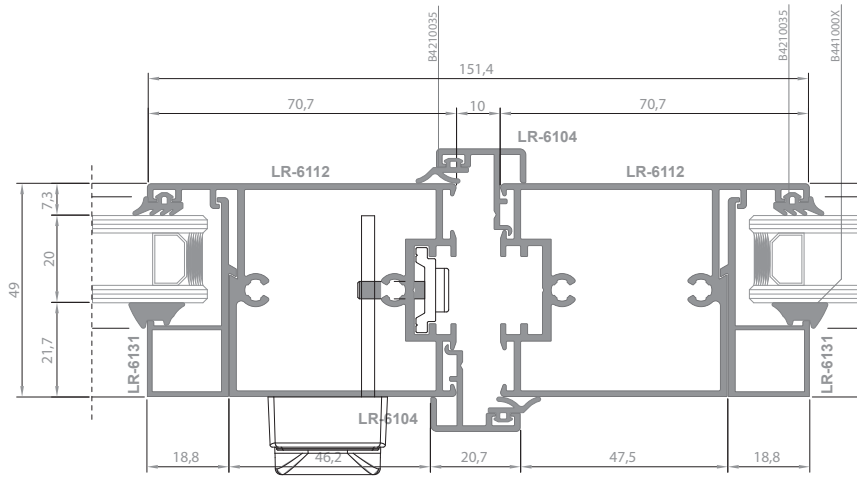

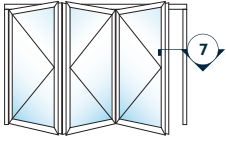



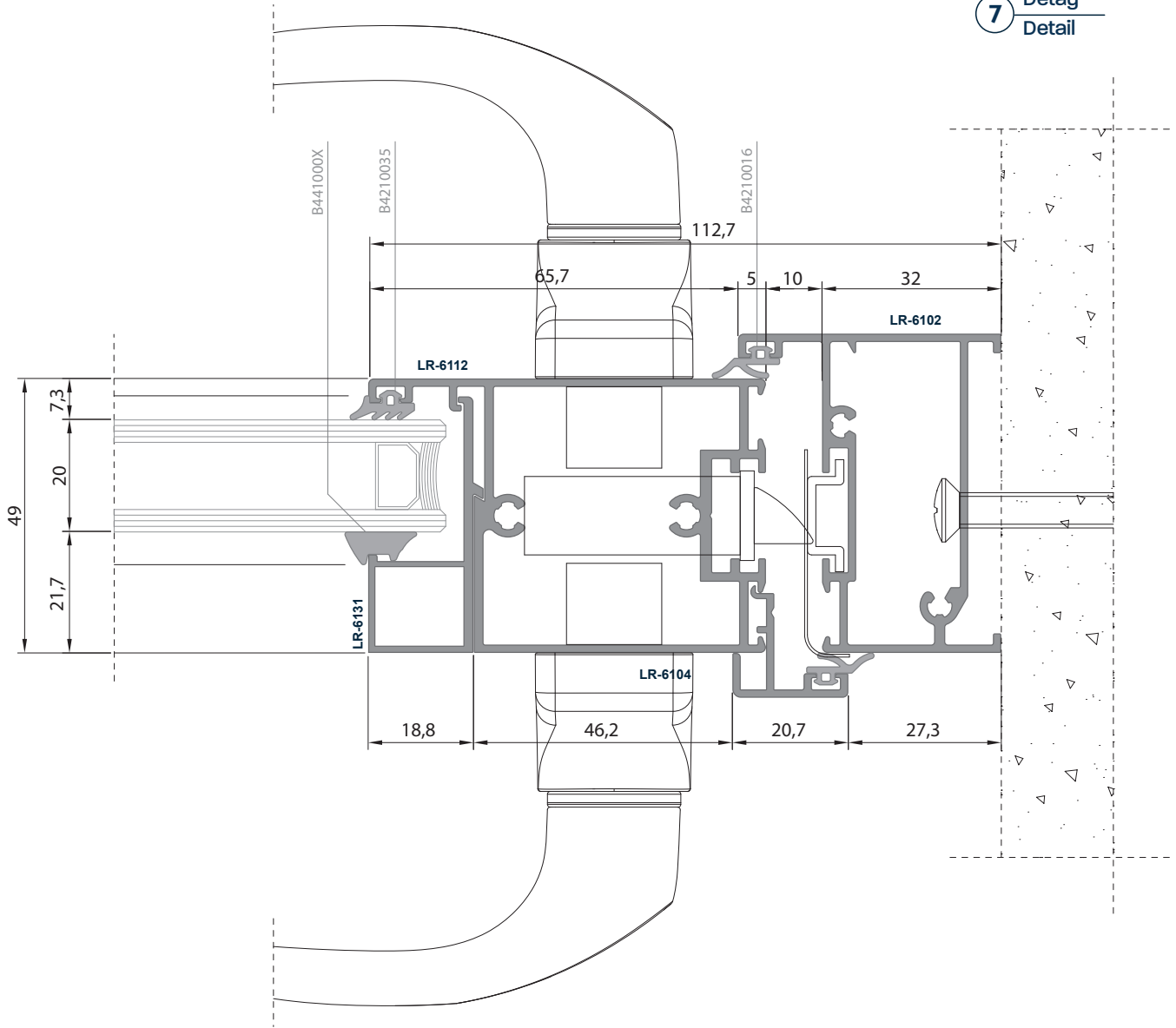

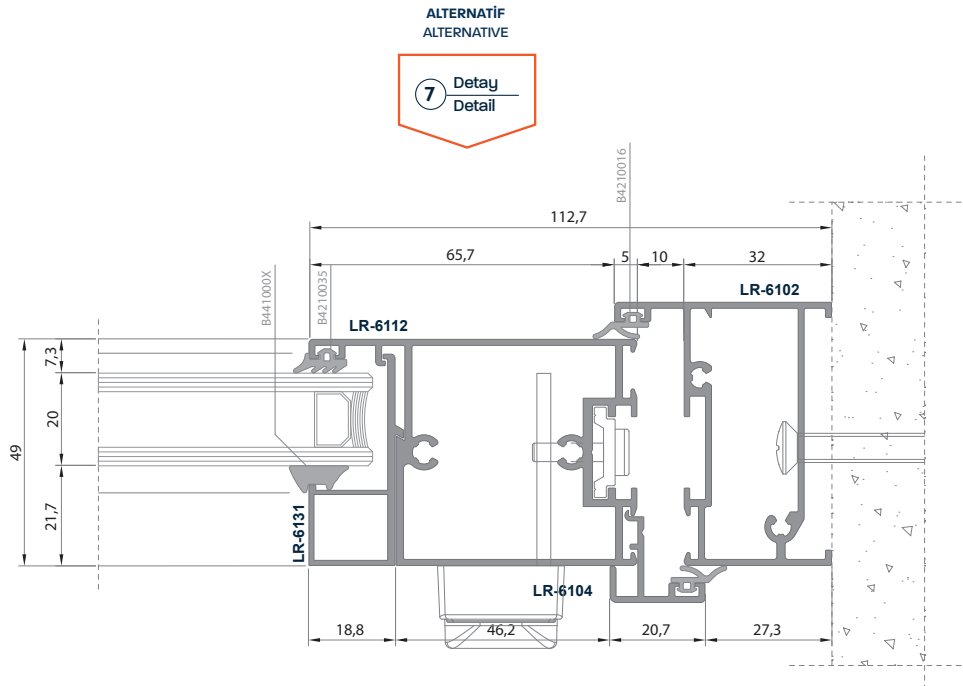
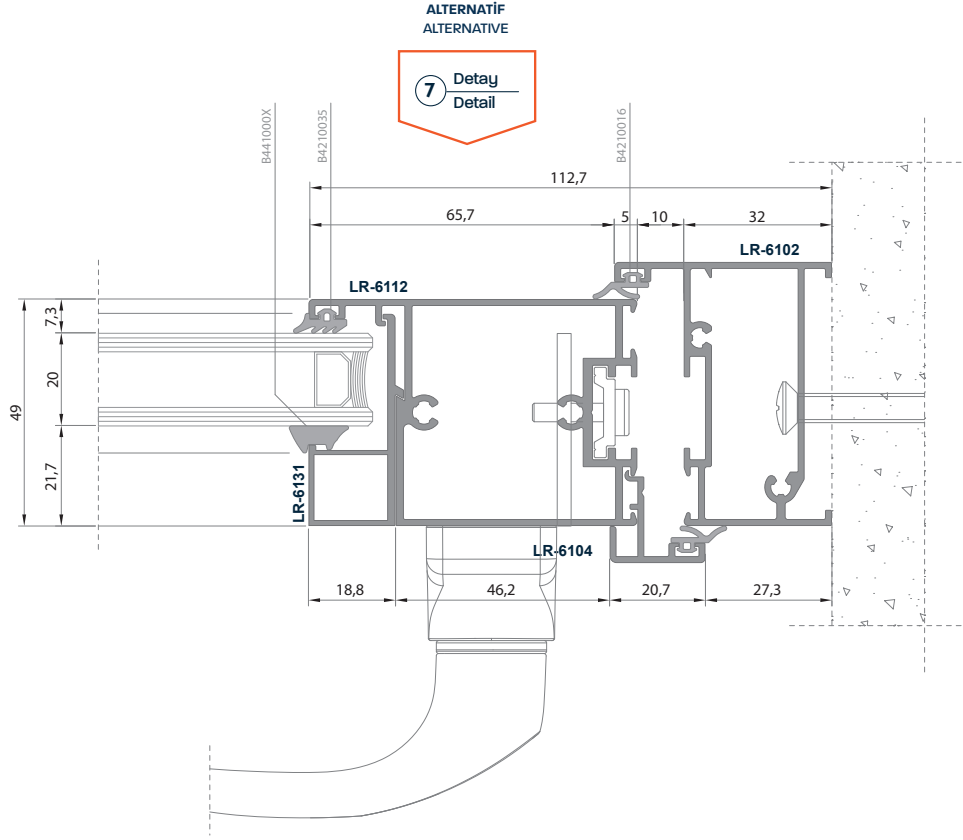
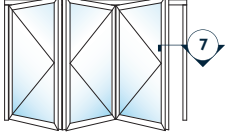

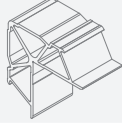

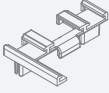
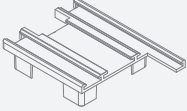
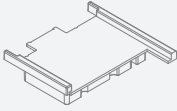
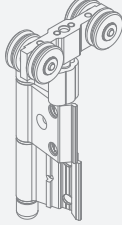
7 Detay
Detail

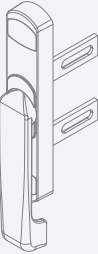

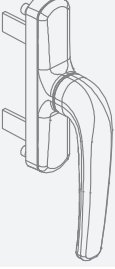
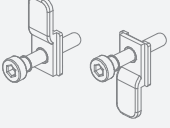

Aksesuarlar Accessories	Aksesuar Kodu Nr of Accessories	Malzeme Türü Material	Açıklama Description	Kullanıldığı Profil Used Profile
	B3129454 <small>(PT)</small>	Alüminyum Aluminum	Pres Köşe Bağlantı Takozu Corner Cleat	LR-3701
	B2110440 <small>(PH)</small>	PVC	45° Kanat Köşe Hizalama 45° Corner Alignment	
	B6100004	PVC	90° dar Kanat Kapak ---	
	B6100005	PVC	90° Geniş Kanat Kapak ---	
	B2316100	PVC	Kasa Yan Kapak ---	
	B6100001	Alüminyum Aluminum	Katlanır Kapı Üst Menteşe Roller Upper Hinge	
	B6100002	Alüminyum Aluminum	Katlanır Kapı Alt Menteşe Lower Alignment Hinge	
	B6100003	Alüminyum Aluminum	Katlanır Kapı Orta Menteşe Hinge For Folding Door	
	B6520014	Alüminyum Aluminum	Katlanır Albatros Kol ---	

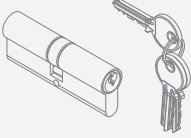
Aksesuarlar Accessories	Aksesuar Kodu Nr of Accessories	Malzeme Türü Material	Açıklama Description	Kullanıldığı Profil Used Profile
	B6520015	Zamak	Katlanır Kapı Kol ---	
	B6520018	Zamak	Katlanır Kol Pimi Side Fixing Kit	
	B6520021	PVC	Kilit Mekanizma Mandalı Slider For Latch	
	B6520013	PVC	Kilit Mekanizması Pim Side Fixing Kit	
	B7410012	Alüminyum Aluminum	Dar Ayna Kapı Kolu Narrow Mirror Door Handle	
	B7312102	Nikel Nickel	Dilli Kilit Lock With Rail	
	B7111010	Nikel Nickel	76 mm. Barel 76 mm. Cylinder	

Aksesuarlar Accessories	Aksesuar Kodu Nr of Accessories	Malzeme Türü Material	Açıklama Description	Kullanım Miktarı amount of usage
	B4210035	EPDM EPDM	3 mm. Dış Cam Fiteli 3 mm. Insulating Gasket	290 mt. 
	B4210016	EPDM EPDM	Kasa Fiteli Frame Gasket	375 mt. 
	B4410007	EPDM EPDM	1,5-2 mm. Cam Fiteli 1,5-2 mm. Wedge Gasket	255 mt. 
	B4410006	EPDM EPDM	2,5-3 mm. Cam Fiteli 2,5-3 mm. Wedge Gasket	194 mt. 
	B4410004	EPDM EPDM	4 mm. Cam Fiteli 4 mm. Wedge Gasket	166 mt. 
	B4410005	EPDM EPDM	5 mm. Cam Fiteli 5 mm. Wedge Gasket	197 mt. 
	B4410008	EPDM EPDM	6 mm. Cam Fiteli 6 mm. Wedge Gasket	120 mt. 
	B4210002	EPDM EPDM	Kanat Hortum Fitel 6 mm. Wedge Gasket	250 mt. 
	B4310005	EPDM EPDM	Üst Bini Fiteli 6 mm. Wedge Gasket	75 mt. 
	B2810039	Polyamid Polyamide	Polyamid Tij Polyamide Rod	200 mt. 
	B4612006	Polipropilen Polypropylene	67x1000 Fırça Fitel 67x1000 Sealing Brush	800 mt. 