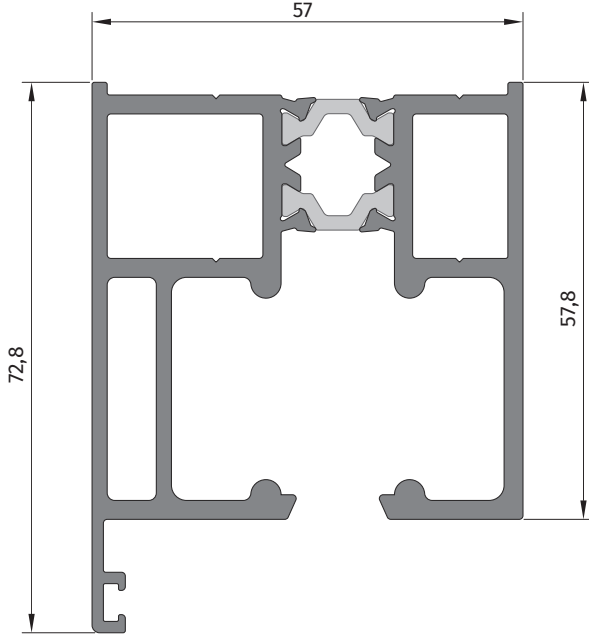

**6200 KATLANIR**  
YALITIMLI SİSTEM

 **ALFORE**<sup>®</sup>

**LR-6201**

Üst Ray Profili  
Upper Rail

Ağırlık (Kg/mt.)  
Weight (Kg/mt.)  
**2,365 Kg/mt.**

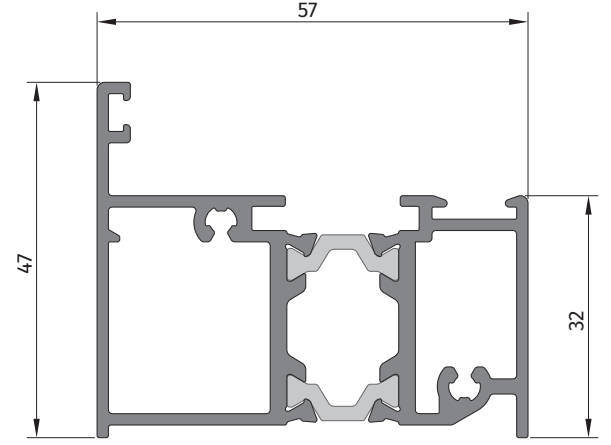
**LR-6202**

Yan kasa profili  
Lateral frame

Ağırlık (Kg/mt.)  
Weight (Kg/mt.)  
**1,400 Kg/mt.**

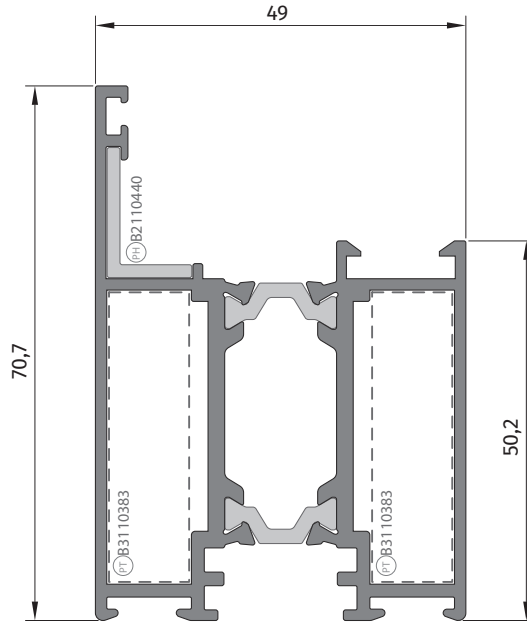
**LR-6203**

45° Kanat profili  
45° Sash profile

Ağırlık (Kg/mt.)  
Weight (Kg/mt.)  
**1,660 Kg/mt.**

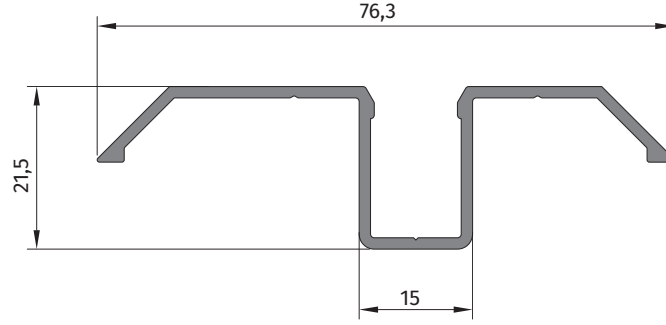
**LR-6105**

Alt ray profili  
Bottom rail

Ağırlık (Kg/mt.)  
Weight (Kg/mt.)  
**0,510 Kg/mt.**

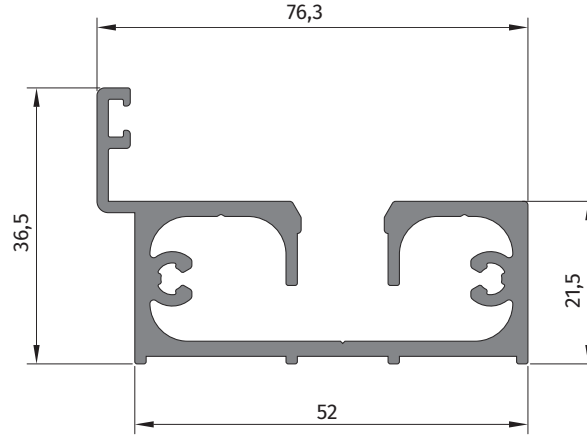
**LR-6106**

Alt ray profili  
Bottom rail

Ağırlık (Kg/mt.)  
Weight (Kg/mt.)  
**1,090 Kg/mt.**

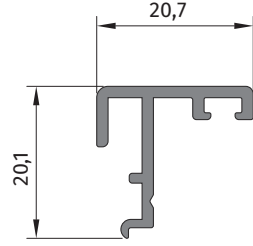
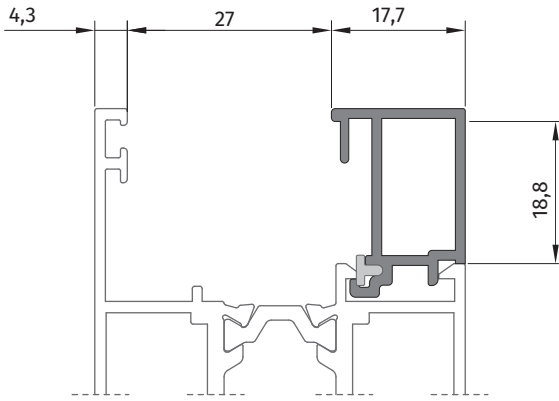
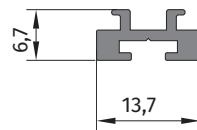
**LR-6104****Tırnak Profili**  
**Leaf Gasket Profile**Ağırlık (Kg/mt.)  
Weight (Kg/mt.)  
**0,221 Kg/mt.****LR-6231****Cam Çıta Profili**  
**Glazing Bead Profile**Ağırlık (Kg/mt.)  
Weight (Kg/mt.)  
**0,300 Kg/mt.****LR-6110****Alt Fital Profili**  
**Profile For Brush**Ağırlık (Kg/mt.)  
Weight (Kg/mt.)  
**0,126 Kg/mt.**

**LR 6200 YALITIMLI KATLANIR SİSTEM**  
**INSULATED BI-FOLD SYSTEM**

---

**45° KANAT AÇILIM TİPLERİ**  
45° TYPES OF OPENING

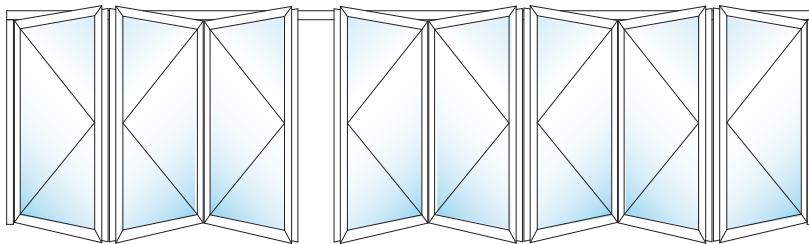
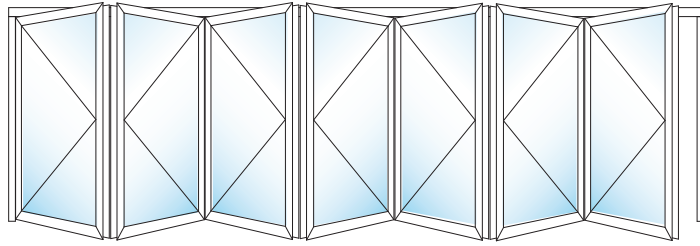
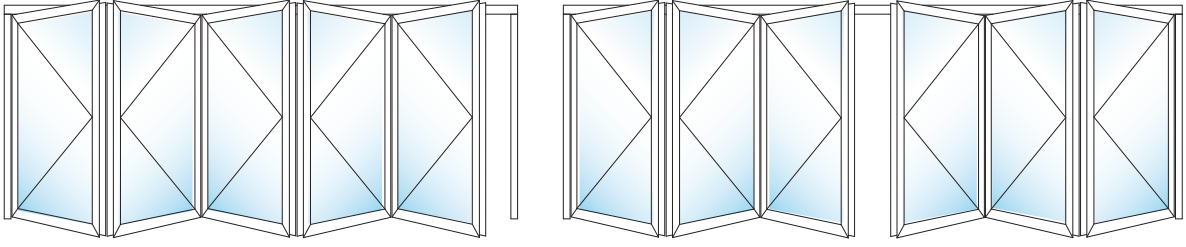
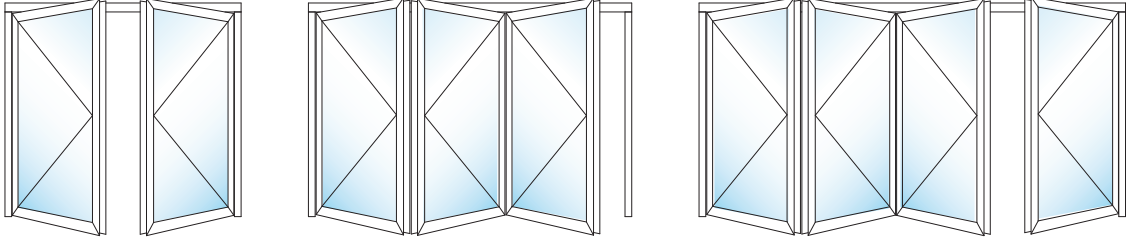

1 Detay  
Detail

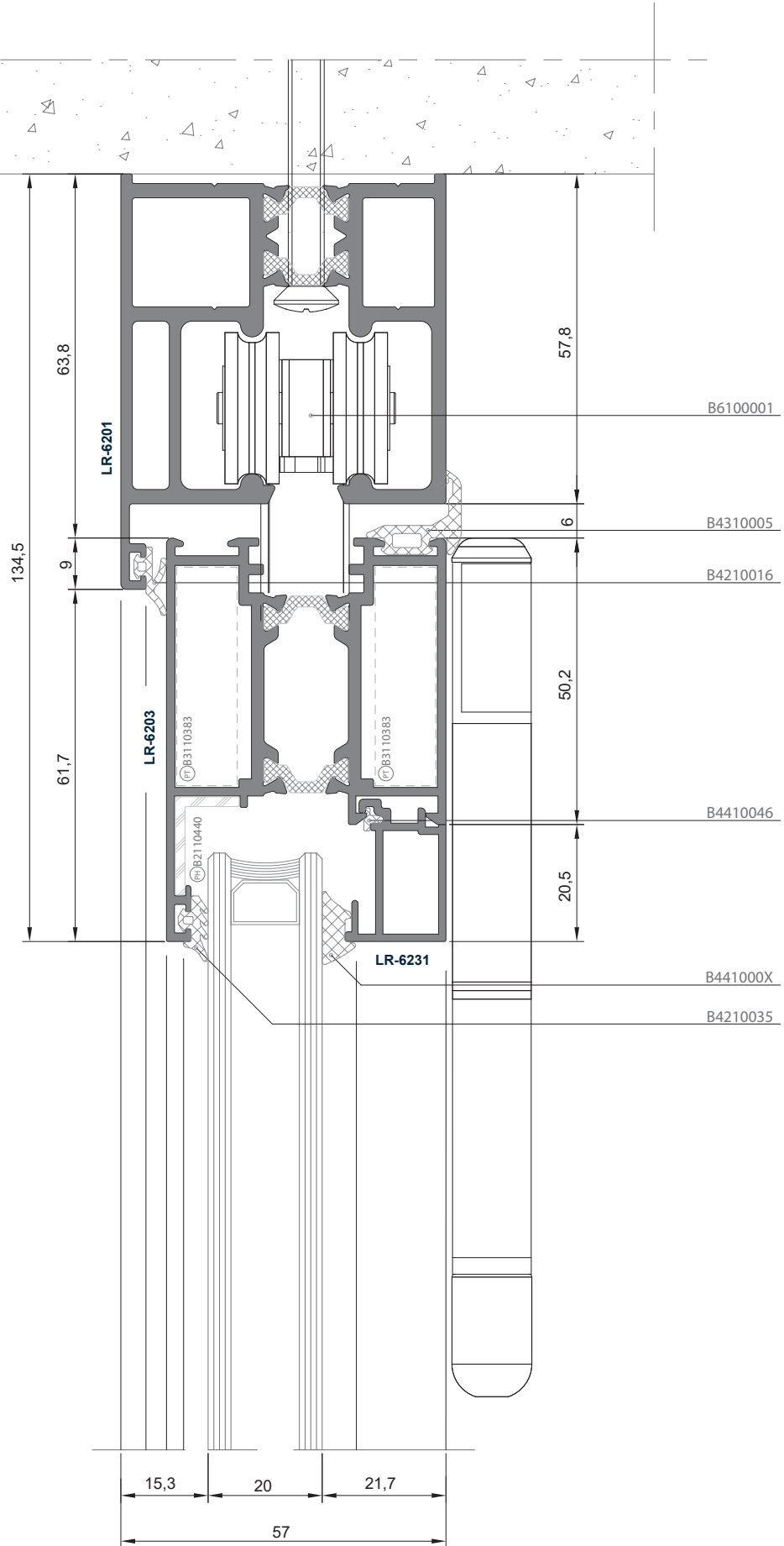
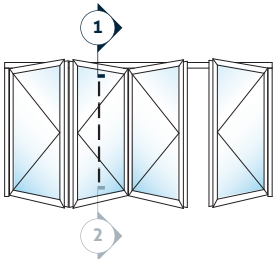
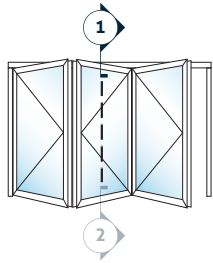

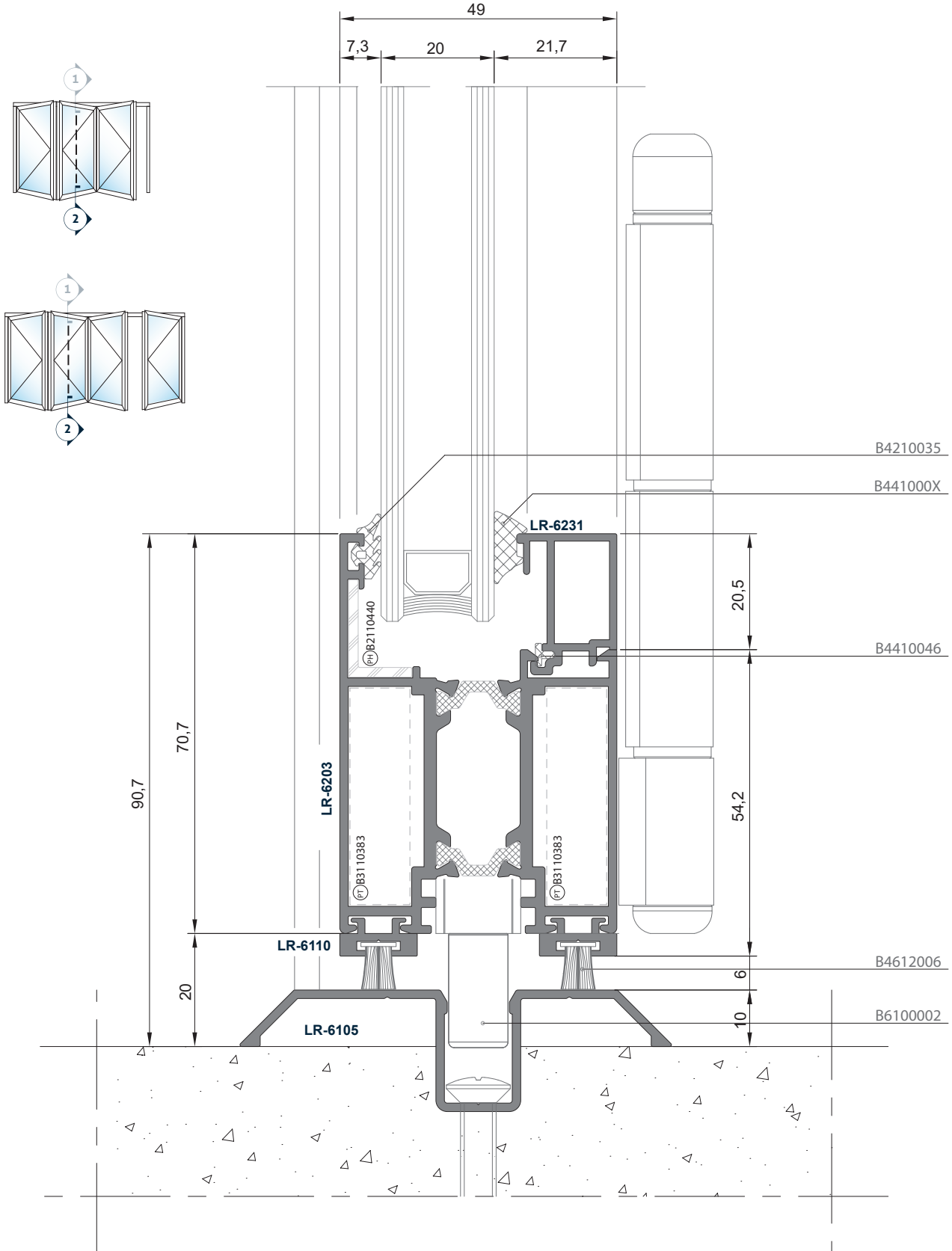
2 Detay  
DetailÖLÇEK: 1:1  
SCALE: 1:1

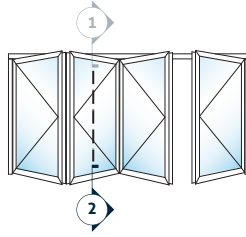
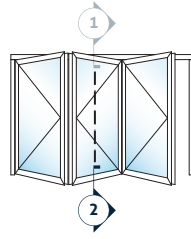

ALTERNATİF  
ALTERNATIVE



ALTERNATİF  
ALTERNATIVE

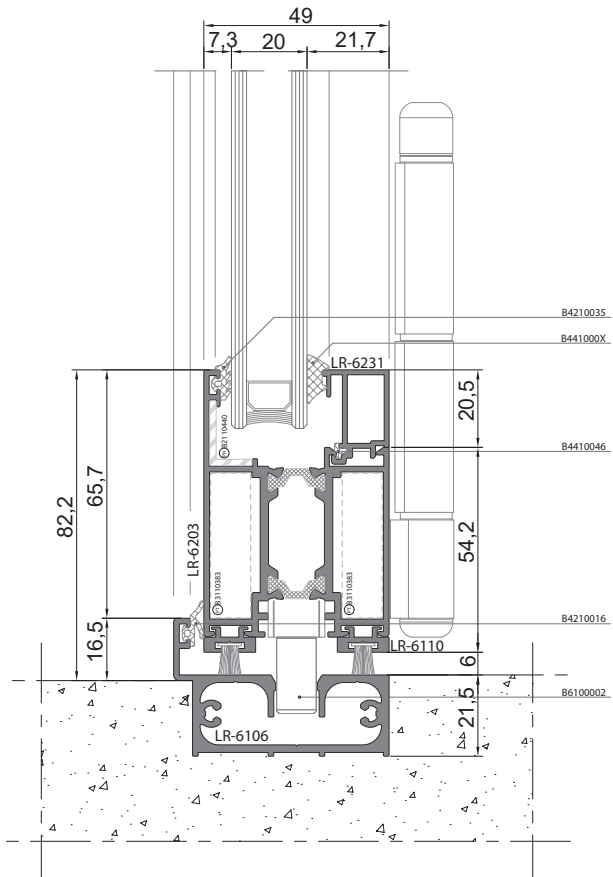
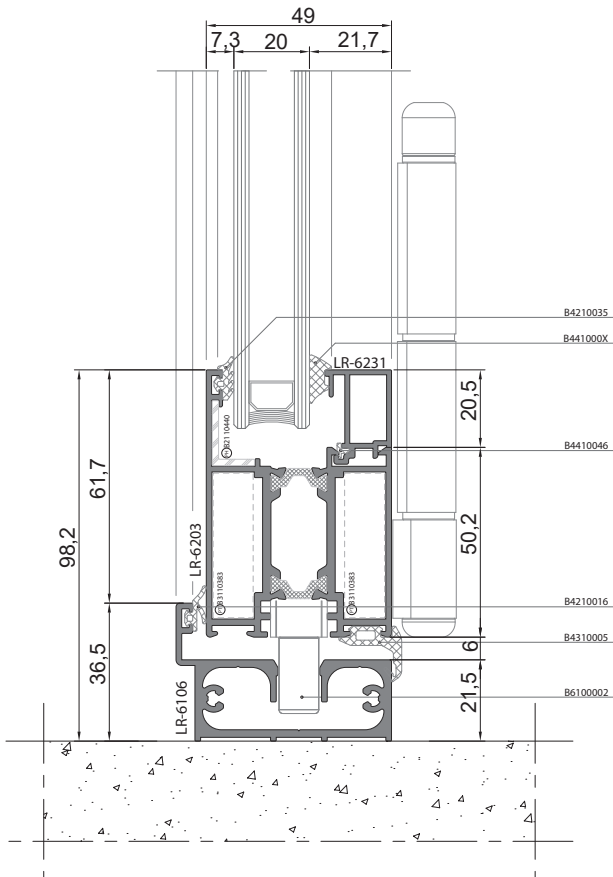



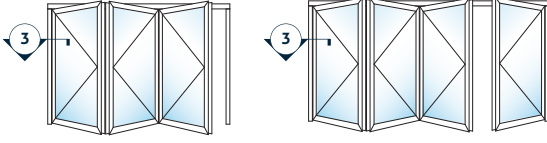

3 Detay  
Detail

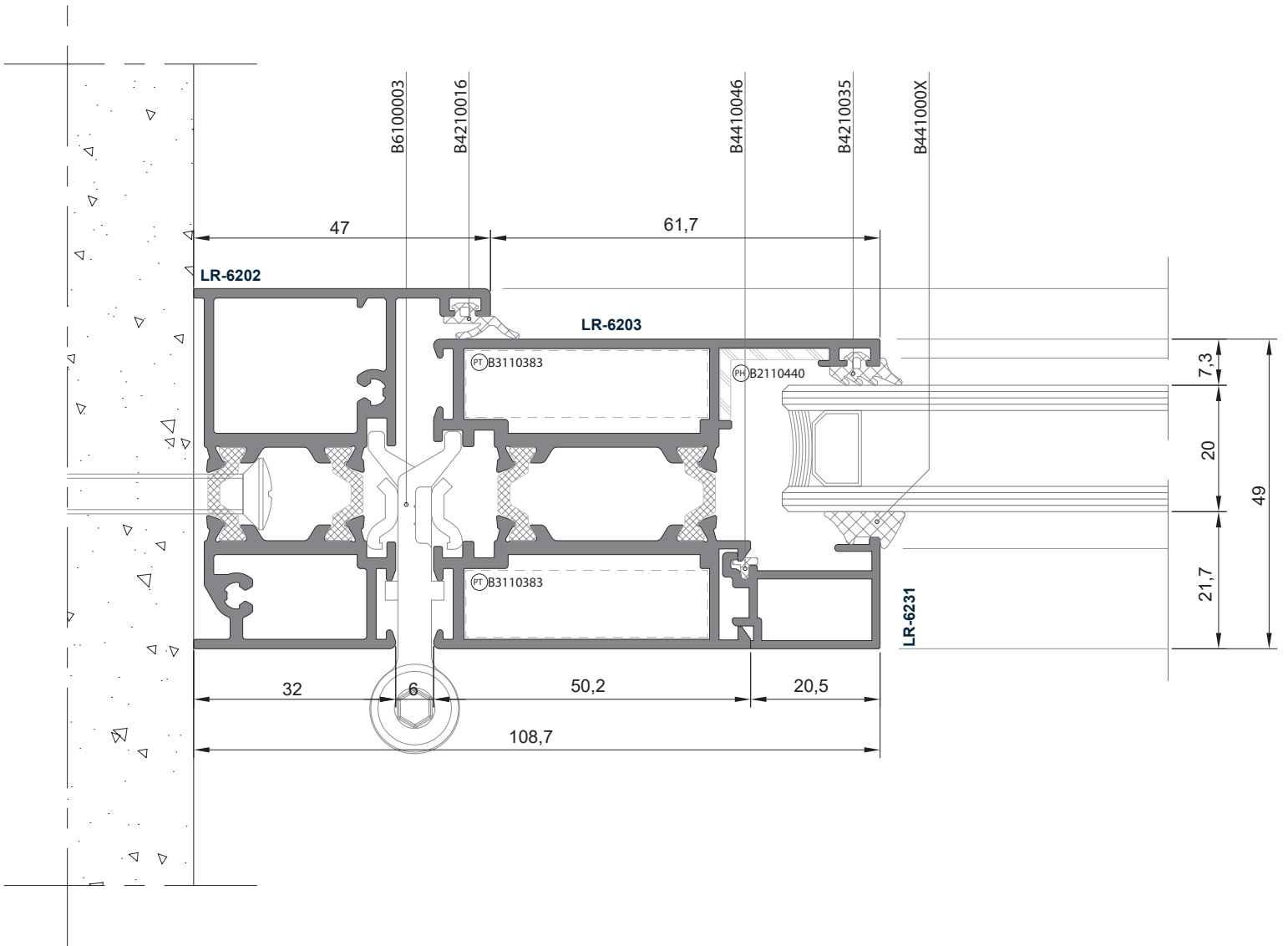

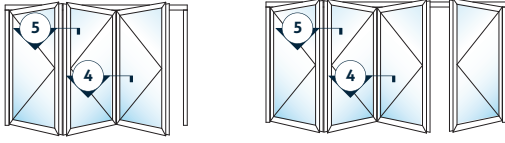

4 Detay  
Detail

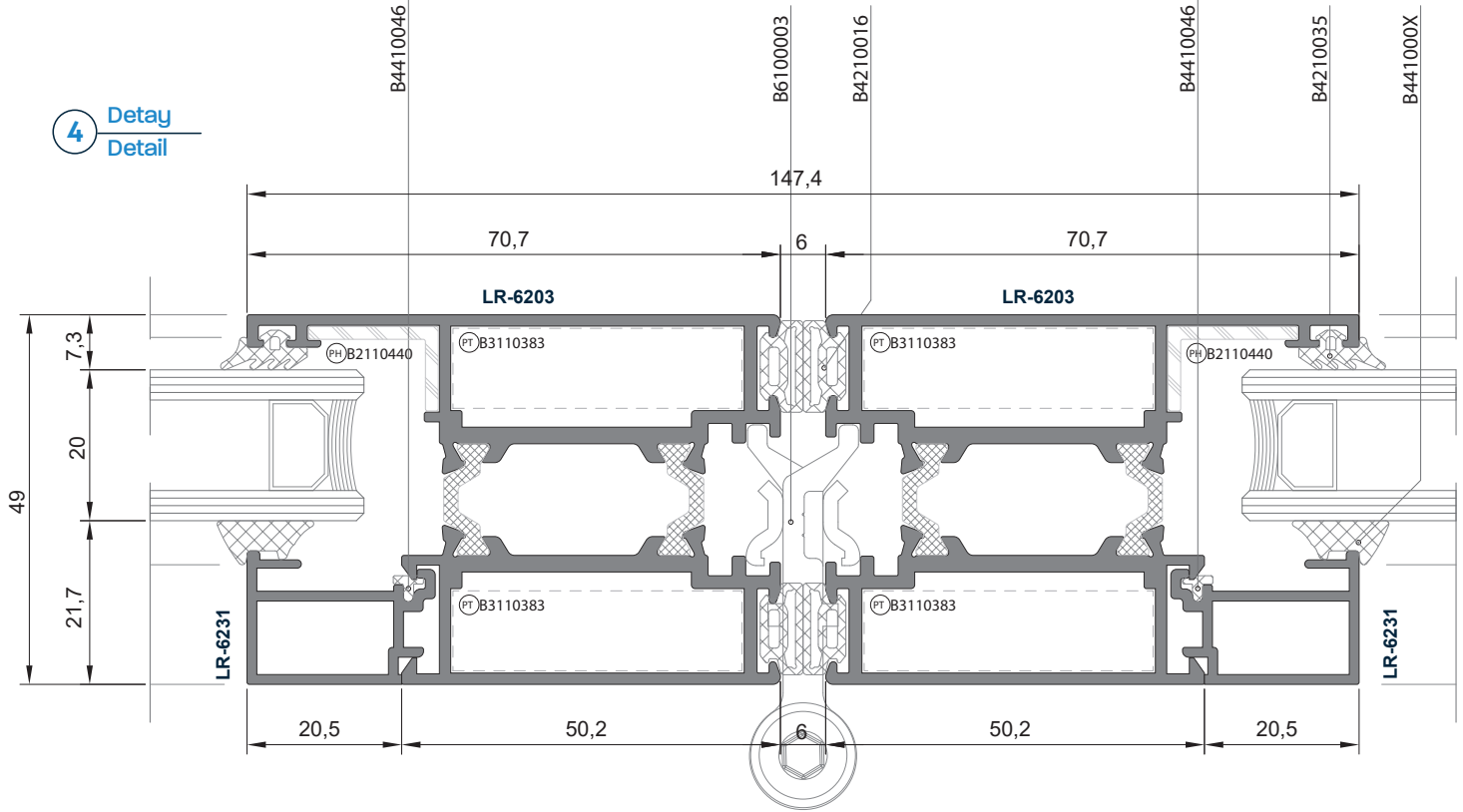

5 Detay  
Detail

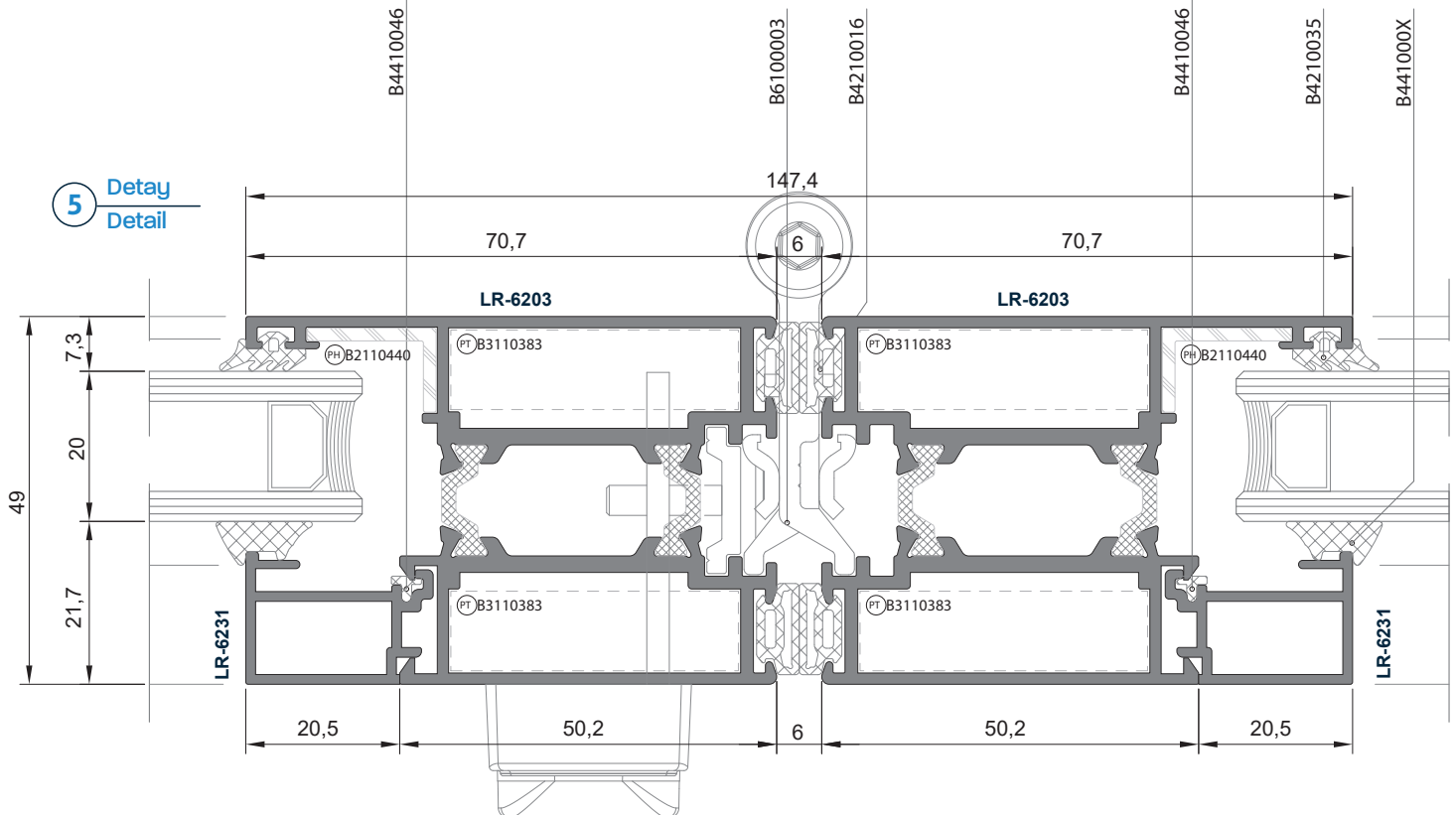

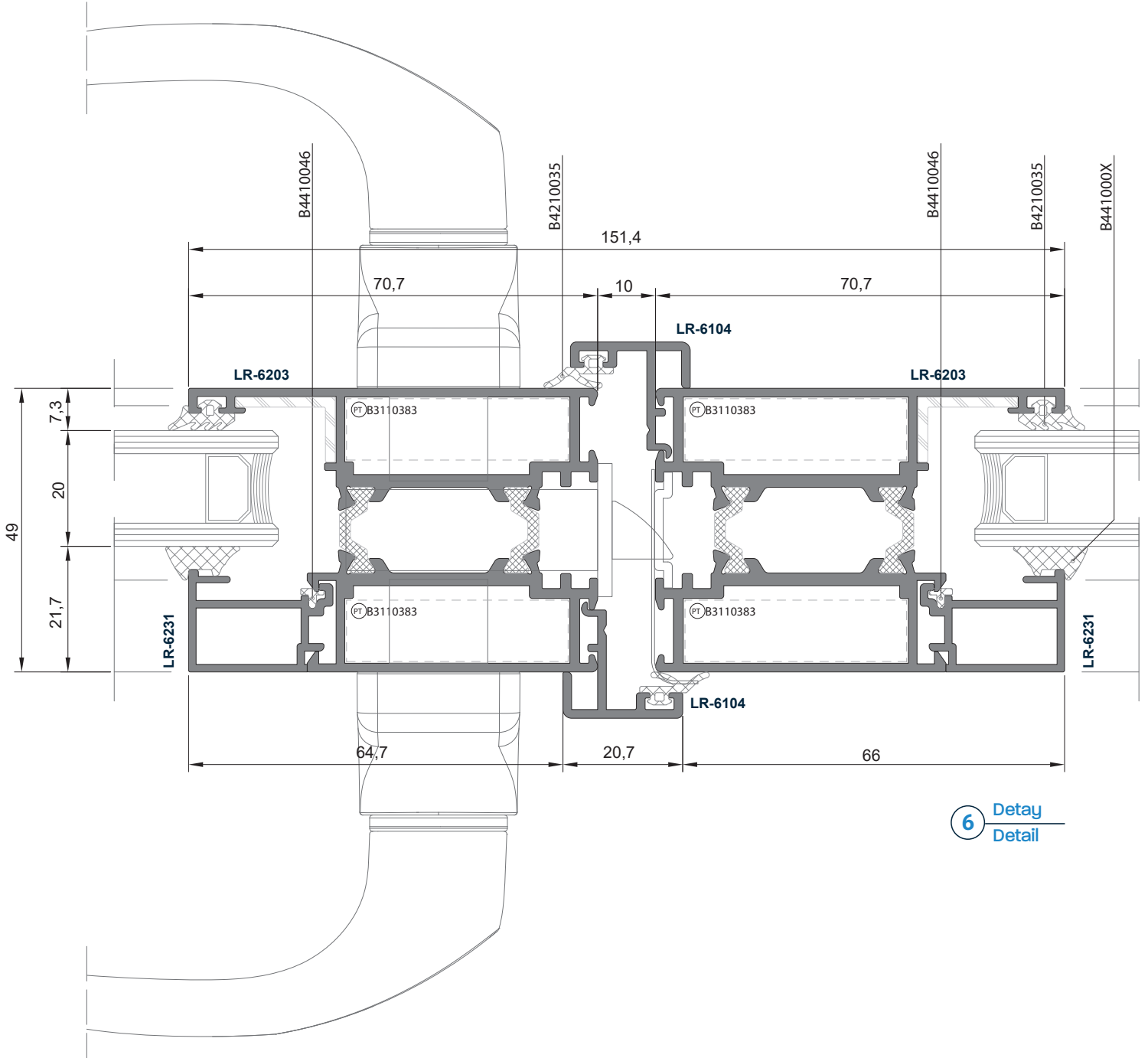
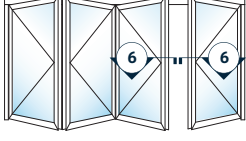

6 Detay  
Detail

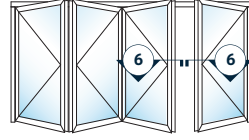

ALTERNATİF  
ALTERNATIVE

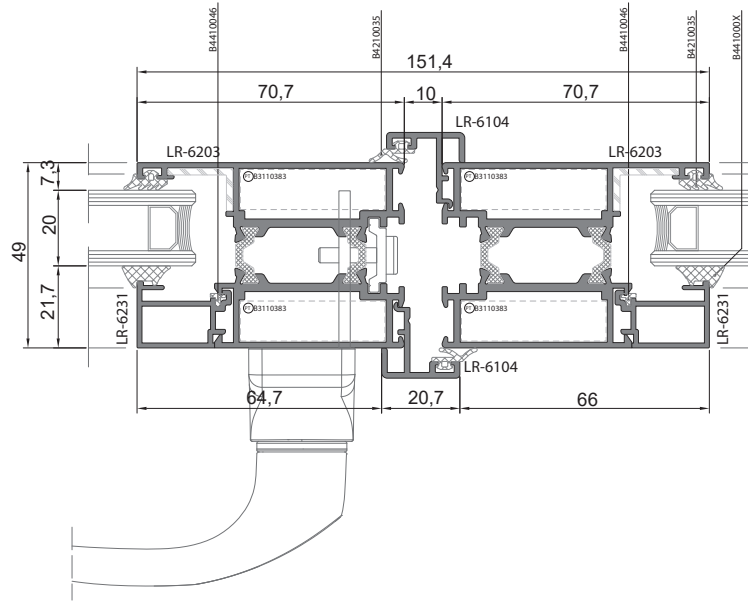

ALTERNATİF  
ALTERNATIVE

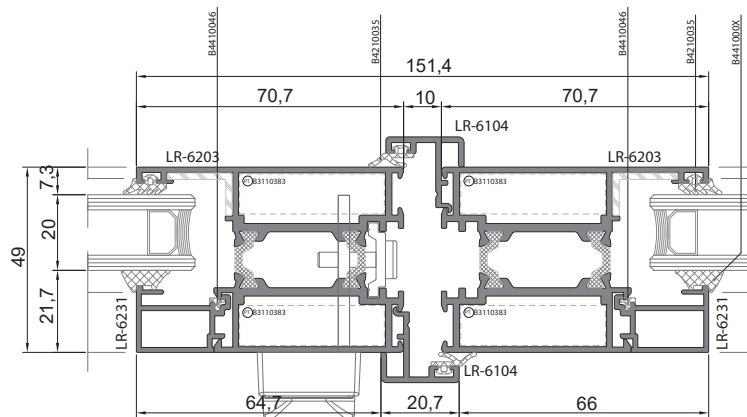

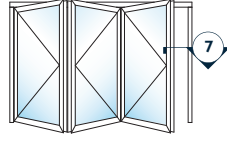

7 Detay  
Detail

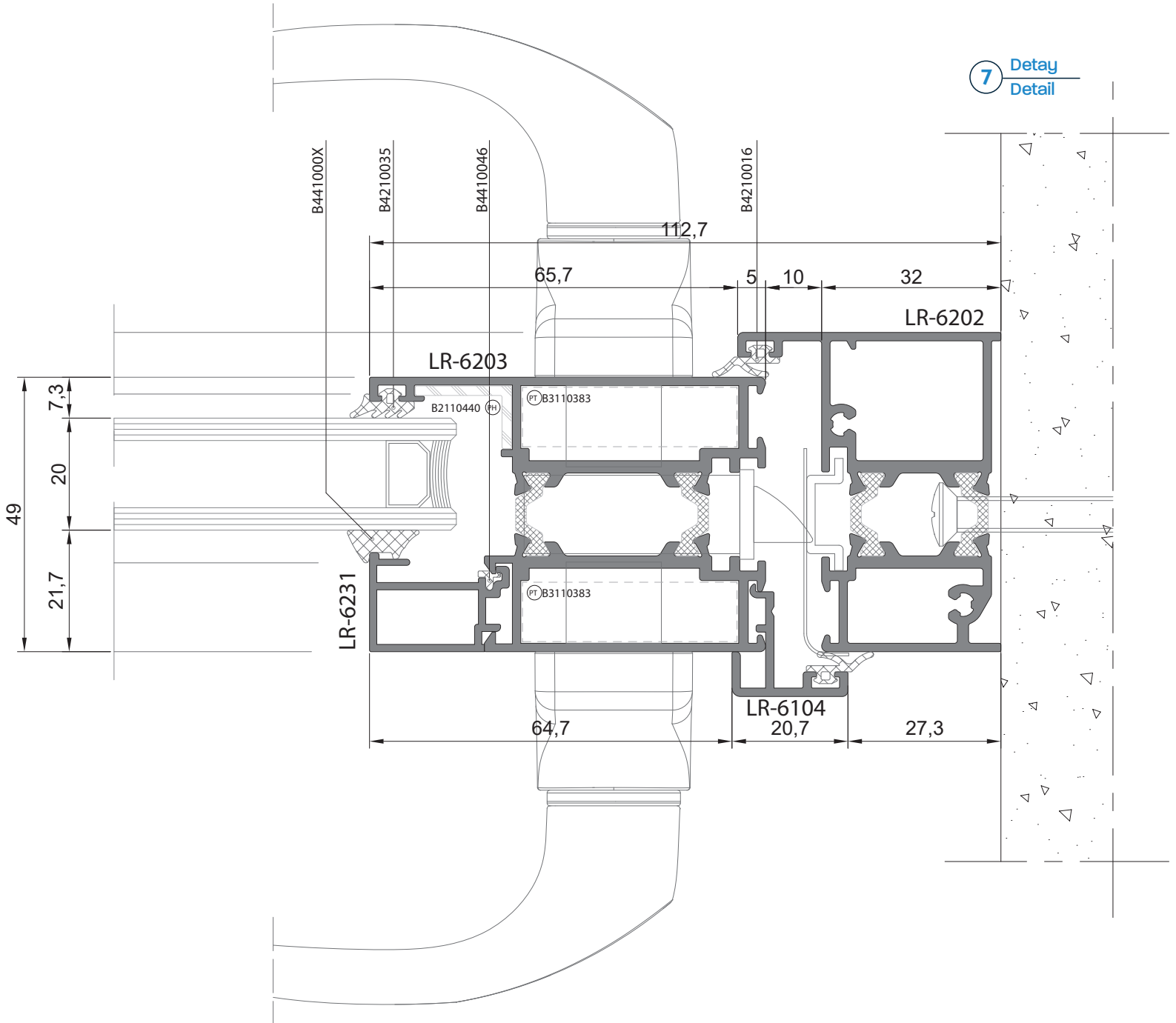

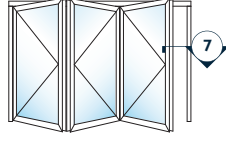

ALTERNATİF  
ALTERNATIVE



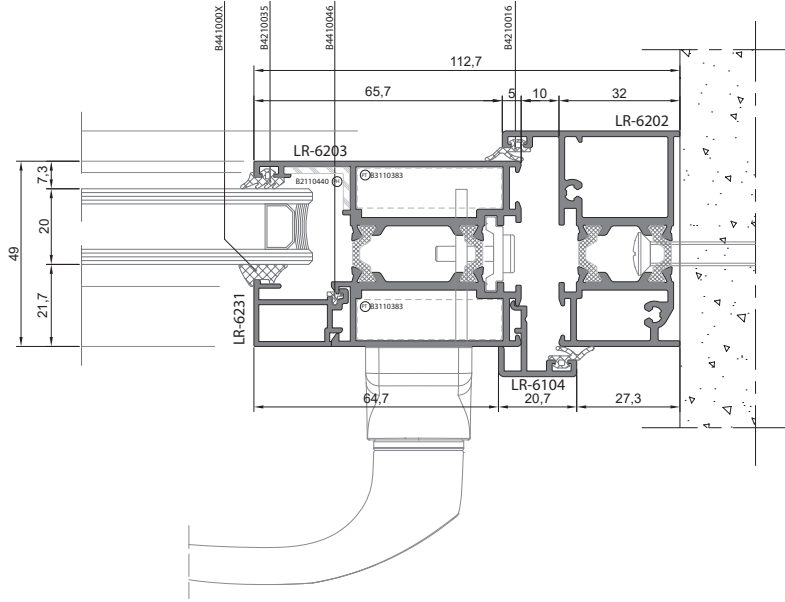





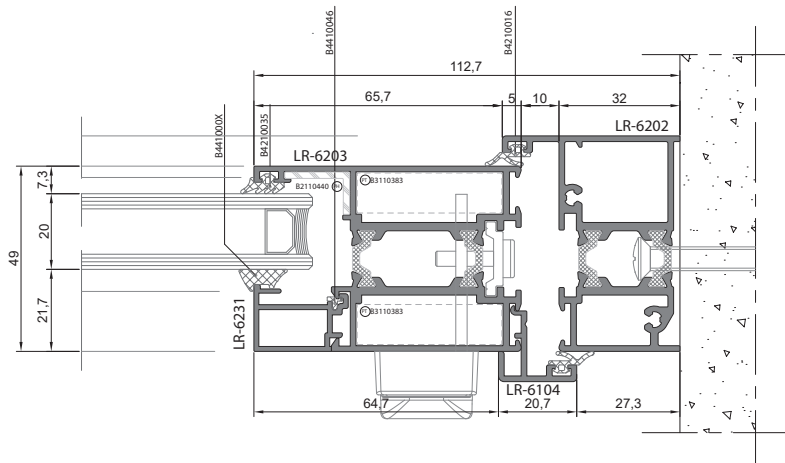

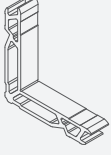



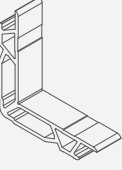



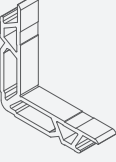

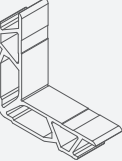

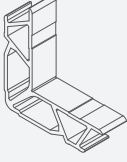

7 Detay  
Detail



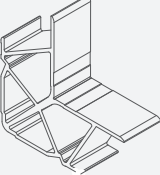

ALTERNATİF  
ALTERNATIVE







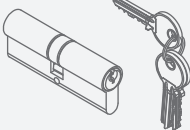









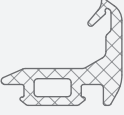



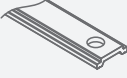

7 Detay  
Detail



Aksesuarlar Accessories	Aksesuar Kodu Nr of Accessories	Malzeme Türü Material	Açıklama Description	Kullanıldığı Profil Used Profile
	 B3113144	Alüminyum Aluminium	12,8 mm. x 14,4 mm. Pres Köşe Takoğu Corner Cleat	LR-5102
	 B3113214		12,8 mm. x 21,4 mm. Pres Köşe Takoğu Corner Cleat	LR-5104
	 B3113295		12,8 mm. x 29,5 mm. Pres Köşe Takoğu Corner Cleat	LR-5105, LR-5130
	 B3113140		12,8 mm. x 14 mm. Pres Köşe Takoğu Corner Cleat	LR-5165, LR-5160
	 B3116194	Alüminyum Aluminium	15,8 mm. x 19,4 mm. Pres Köşe Takoğu Corner Cleat	LR-5102, LR-5104, LR-5105, LR-5130, LR-5160, LR-5165
	 B3116074		15,8 mm. x 7,4 mm. Pres Köşe Takoğu Corner Cleat	LR-5122, LR-5125
	 B3116298		15,8 mm. x 29,8mm. Pres Köşe Takoğu Corner Cleat	LR-5122, LR-5123 LR-5125
	 B3117144	Alüminyum Aluminium	16,6 mm. x 14,4mm. Pres Köşe Takoğu Corner Cleat	LR-5111
	 B3119144	Alüminyum Aluminium	19,6 mm. x 14,4 mm. Pres Köşe Takoğu Corner Cleat	LR-5101, LR-5106 LR-5107
	 B3119214		19,6 mm. x 21,4 mm. Pres Köşe Takoğu Corner Cleat	LR-5103
	 B3119257		19,6 mm. x 25,7 mm. Pres Köşe Takoğu Corner Cleat	LR-5162
	 B3123194	Alüminyum Aluminium	22,6 mm. x 19,4 mm. Pres Köşe Takoğu Corner Cleat	LR-5101, LR-5103 LR-5106, LR-5111
	 B3123074		22,6 mm. x 7,4 mm. Pres Köşe Takoğu Corner Cleat	LR-5121, LR-5123 LR-5124
	 B3123298		22,6 mm. x 29,8 mm. Pres Köşe Takoğu Corner Cleat	LR-5121, LR-5124
	 B3123151		22,6 mm. x 15,1 mm. Pres Köşe Takoğu Corner Cleat	LR-5107
	 B3138109	Alüminyum Aluminium	38,3 mm.x 10,9 mm. Pres Köşe Takoğu Corner Cleat	LR-5106
	 B3143074	Alüminyum Aluminium	43 mm. x 7,4 mm. Pres Köşe Takoğu Corner Cleat	LR-5126, LR-5127 LR-5128
	 B3143296		43 mm. x 29,6 mm. Pres Köşe Takoğu Corner Cleat	LR-5126, LR-5127
	 B3143250		43 mm. x 25 mm. Pres Köşe Takoğu Corner Cleat	LR-5128

Aksesuarlar Accessories	Aksesuar Kodu Nr of Accessories	Malzeme Türü Material	Açıklama Description	Kullanıldığı Profil Used Profile
	B6520021	PVC	Kilit Mekanizma Mandalı Slider For Latch	
	B6520013	PVC	Kilit Mekanizması Pim Side Fixing Kit	
	B7410012	Alüminyum Aluminum	Dar Ayna Kapı Kolu Narrow Mirror Door Handle	
	B7312102	Nikel Nickel	Dilli Kilit Lock With Rail	
	B7111010	Nikel Nickel	76 mm. Barel 76 mm. Cylinder	



Aksesuarlar Accessories	Aksesuar Kodu Nr of Accessories	Malzeme Türü Material	Açıklama Description	Kullanım Miktarı Amount of usage
	B4410005	EPDM EPDM	5 mm. Cam Fıtlı 5 mm. Wedge Gasket	197 mt. 
	B4410008	EPDM EPDM	6 mm. Cam Fıtlı 6 mm. Wedge Gasket	120 mt. 
	B4210002	EPDM EPDM	Kanat Hortum Fıtlı 6 mm. Wedge Gasket	250 mt. 
	B4310005	EPDM EPDM	Üst Bini Fıtlı 6 mm. Wedge Gasket	75 mt. 
	B4410046	TPE TPE	Çıta Destek Fıtlı Glazing Bead Gasket	1000 mt. 
	B2810039	Polyamid Polyamide	Polyamid Tij Polyamide Rod	200 mt. 
	B4612006	Polipropilen Polypropylene	67x1000 Fırça Fıtlı 67x1000 Sealing Brush	800 mt. 
	B4210035	EPDM EPDM	3 mm. Dış Cam Fıtlı 3 mm. Insulating Gasket	290 mt. 
	B4210016	EPDM EPDM	Kasa Fıtlı Frame Gasket	375 mt. 
	B4410007	EPDM EPDM	1,5-2 mm. Cam Fıtlı 1,5-2 mm. Wedge Gasket	255 mt. 
	B4410006	EPDM EPDM	2,5-3 mm. Cam Fıtlı 2,5-3 mm. Wedge Gasket	194 mt. 
	B4410004	EPDM EPDM	4 mm. Cam Fıtlı 4 mm. Wedge Gasket	166 mt. 