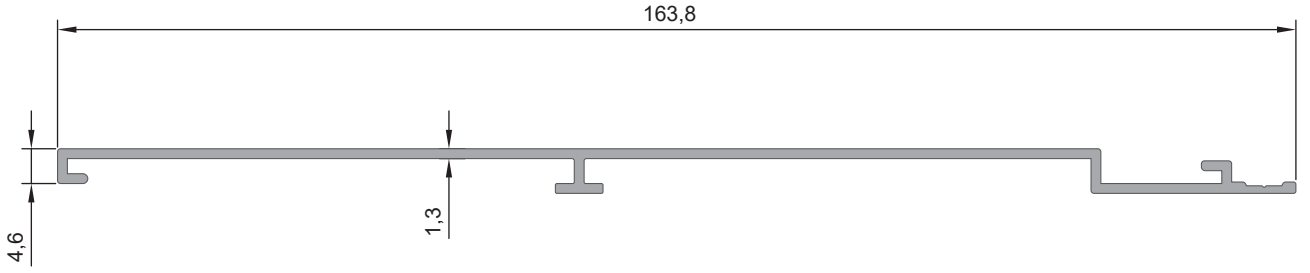
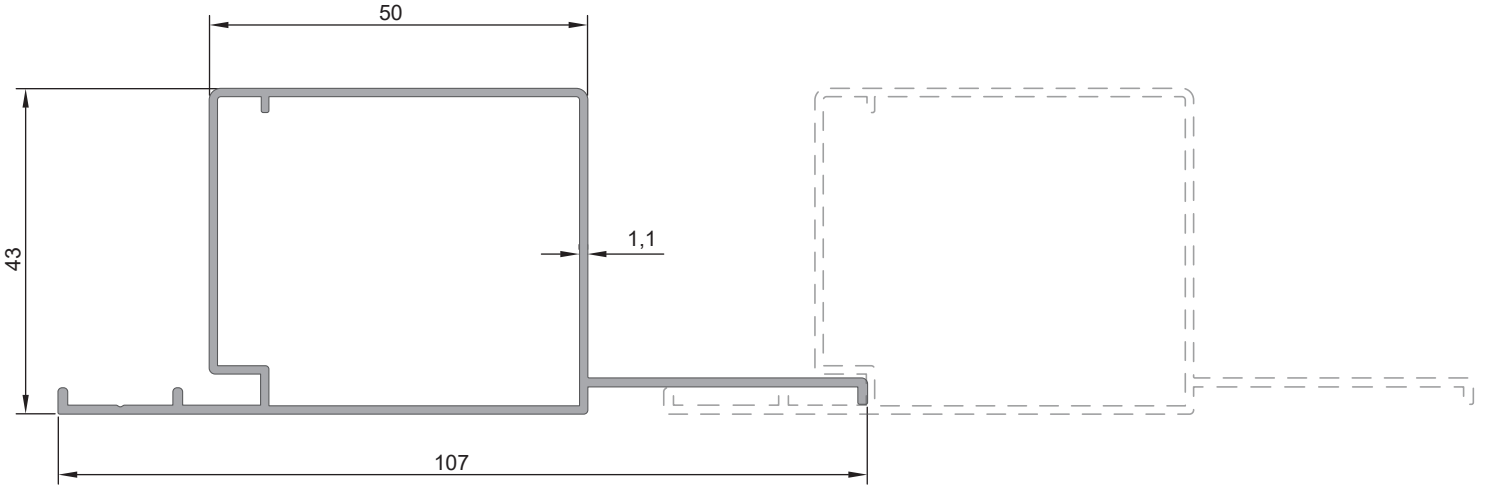
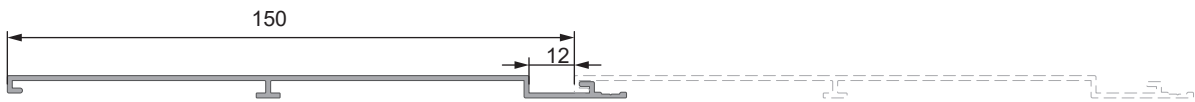

CEPHE-TAVAN KAPLAMA
BÖLME SİSTEMİ

 **ALFORE®**

11283

Cephe Dekor Profili

Ağırlık (Kg/mt.)
0,756 Kg/mt.**11287**15'Lik
Düz Lambri ProfiliAğırlık (Kg/mt.)
0,665 Kg/mt.

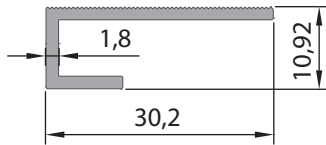
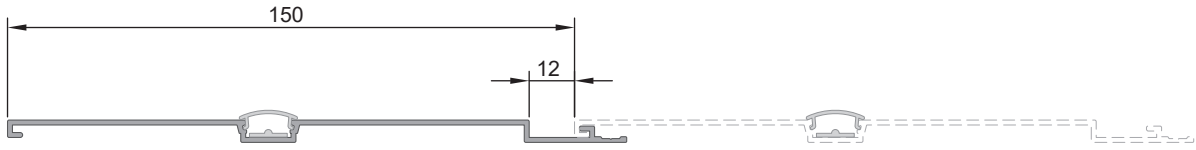
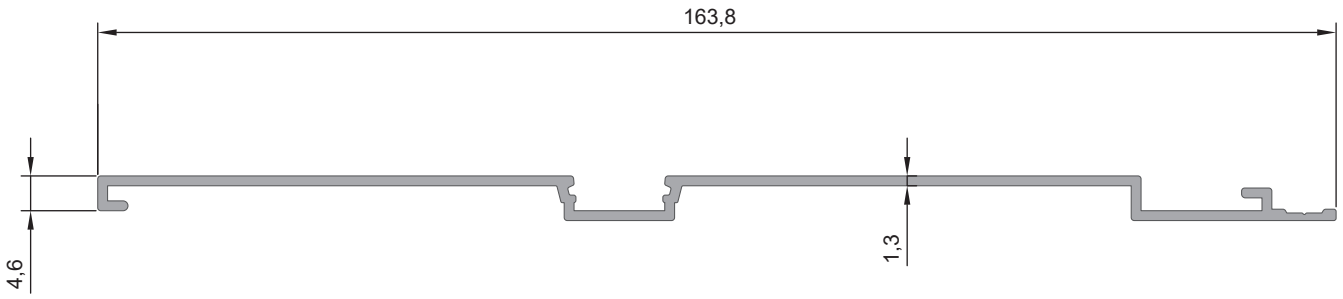
11285Tavan Lambri Profili
(150'lik)Ağırlık (Kg/mt.)
0,667 Kg/mt.**2829**

Sinterflex Askı Profili Orta

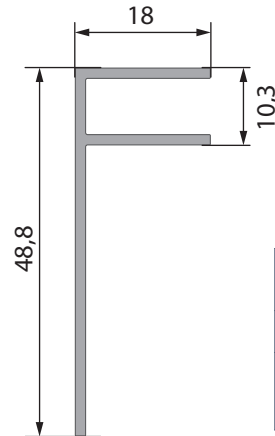
Ağırlık (Kg/mt.)
0,227 Kg/mt.**11286**

F Profil

Ağırlık (Kg/mt.)
0,333 Kg/mt.

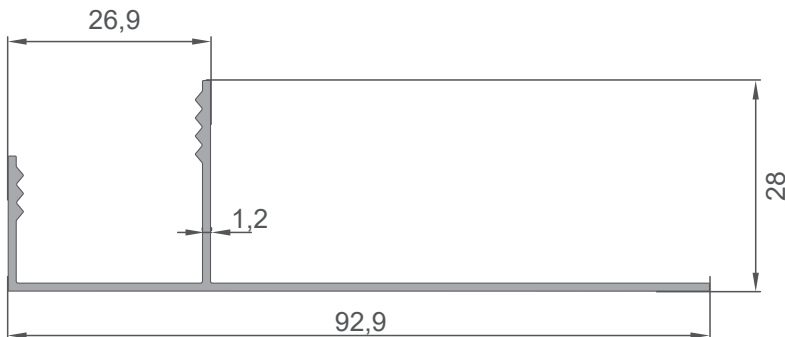
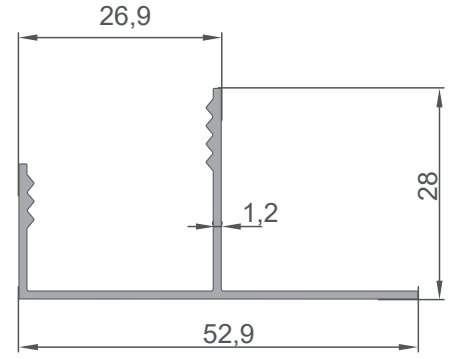
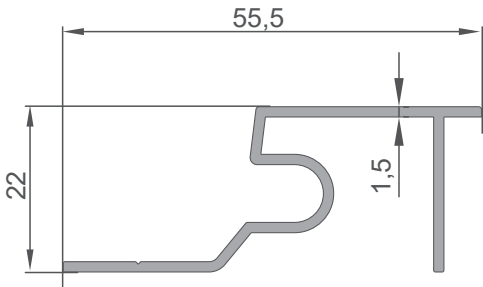
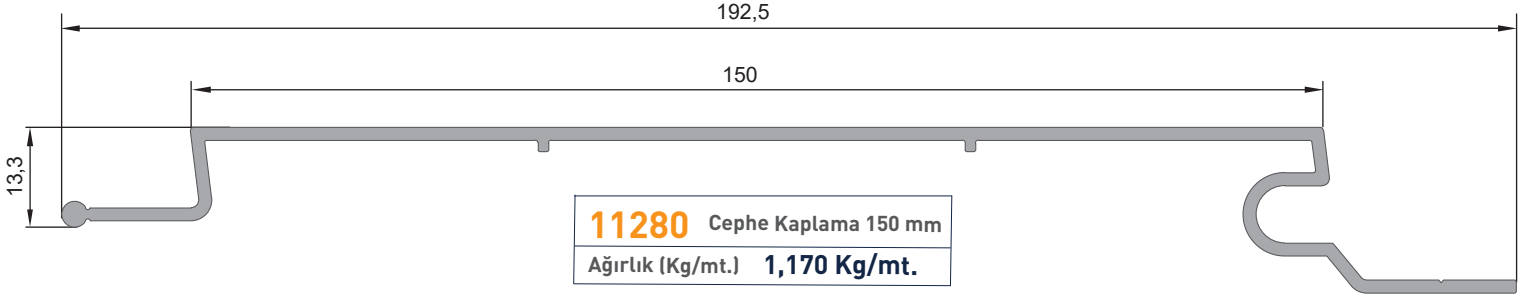

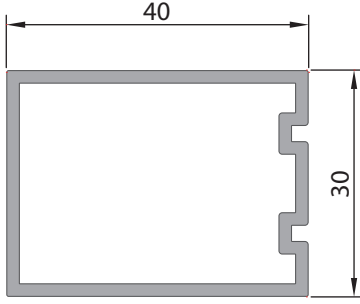
**1701**

Dikme Profili

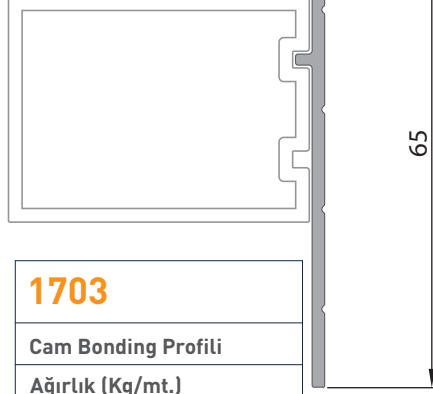
Ağırlık (Kg/mt.)
0,690 Kg/mt.**1703**

Cam Bonding Profili

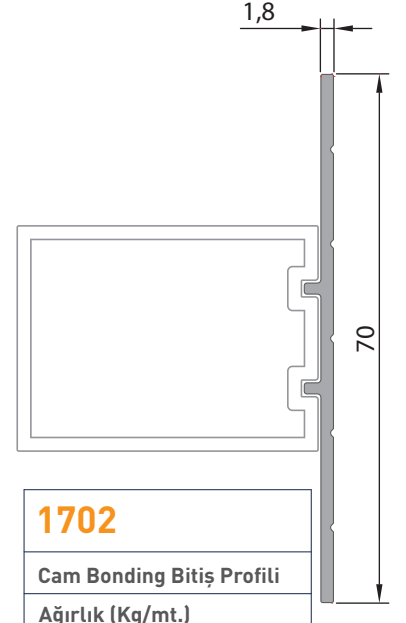
Ağırlık (Kg/mt.)
0,363 Kg/mt.**1702**

Cam Bonding Bitiş Profili

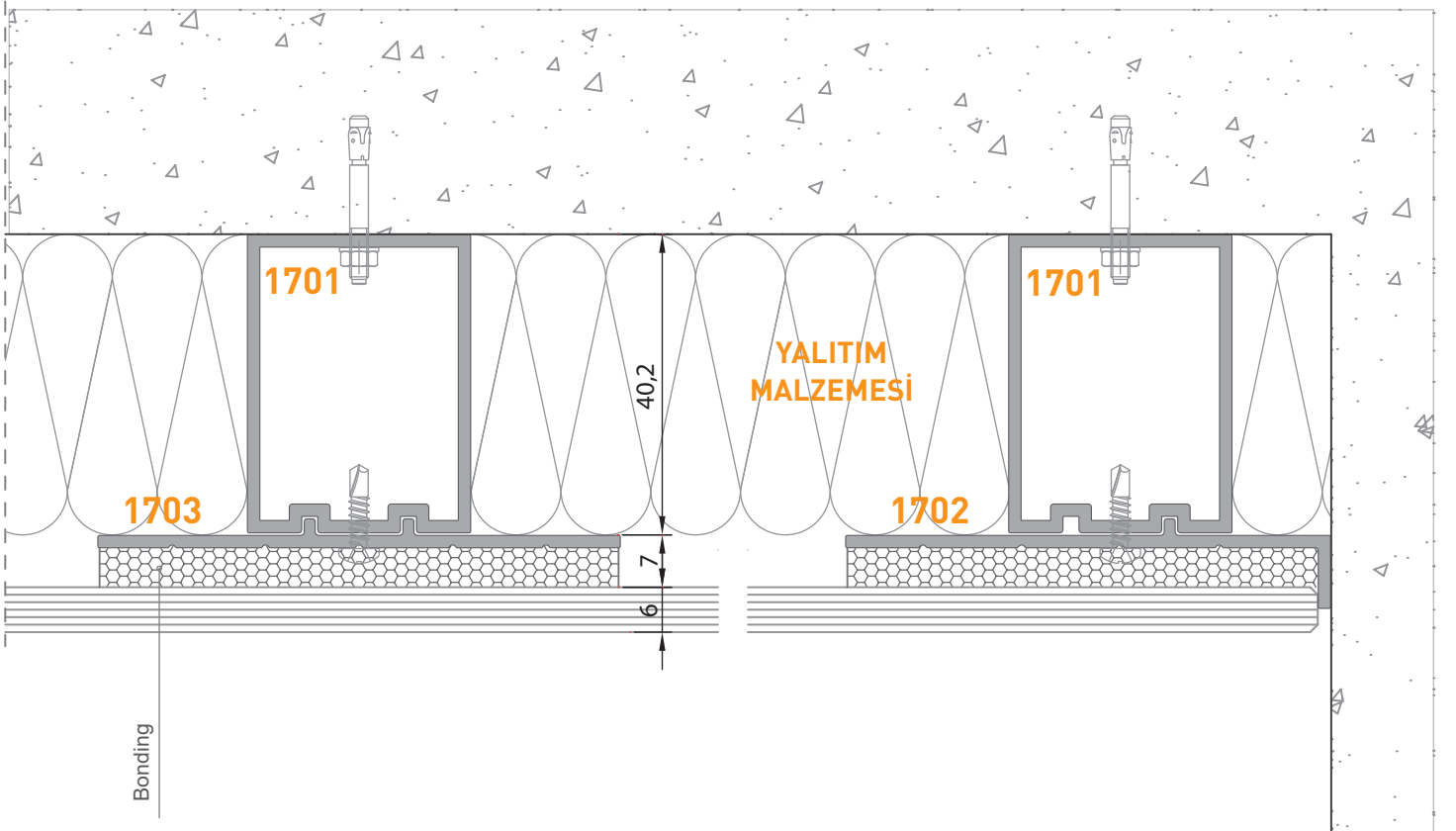
Ağırlık (Kg/mt.)
0,357 Kg/mt.

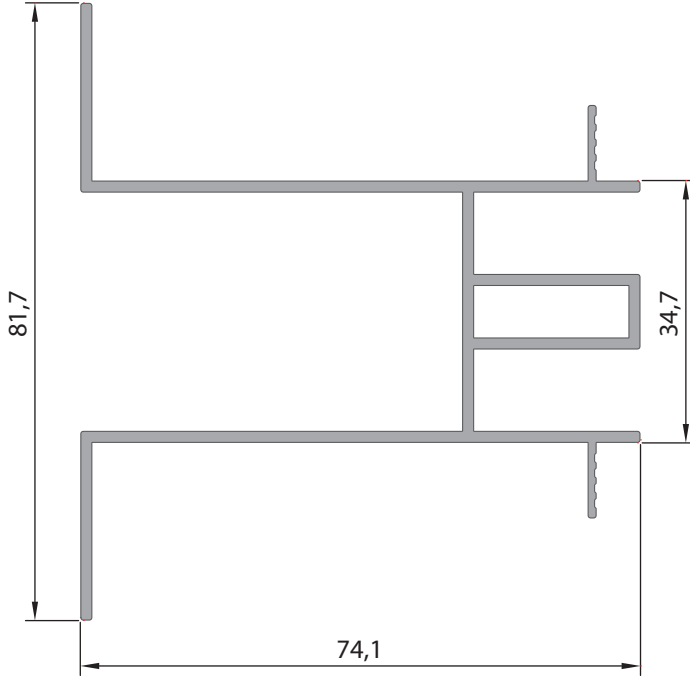
**0191**

Düşey Profil

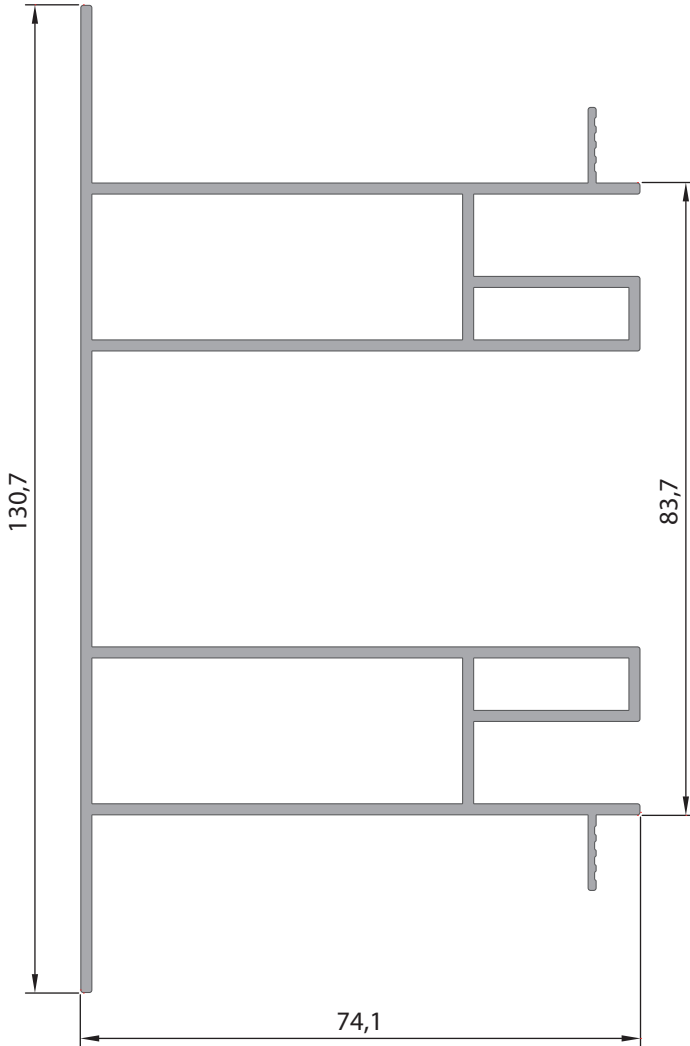
Ağırlık (Kg/mt.)
1,263 Kg/mt.**0190**

Yatay Profil

Ağırlık (Kg/mt.)
2,300 Kg/mt.

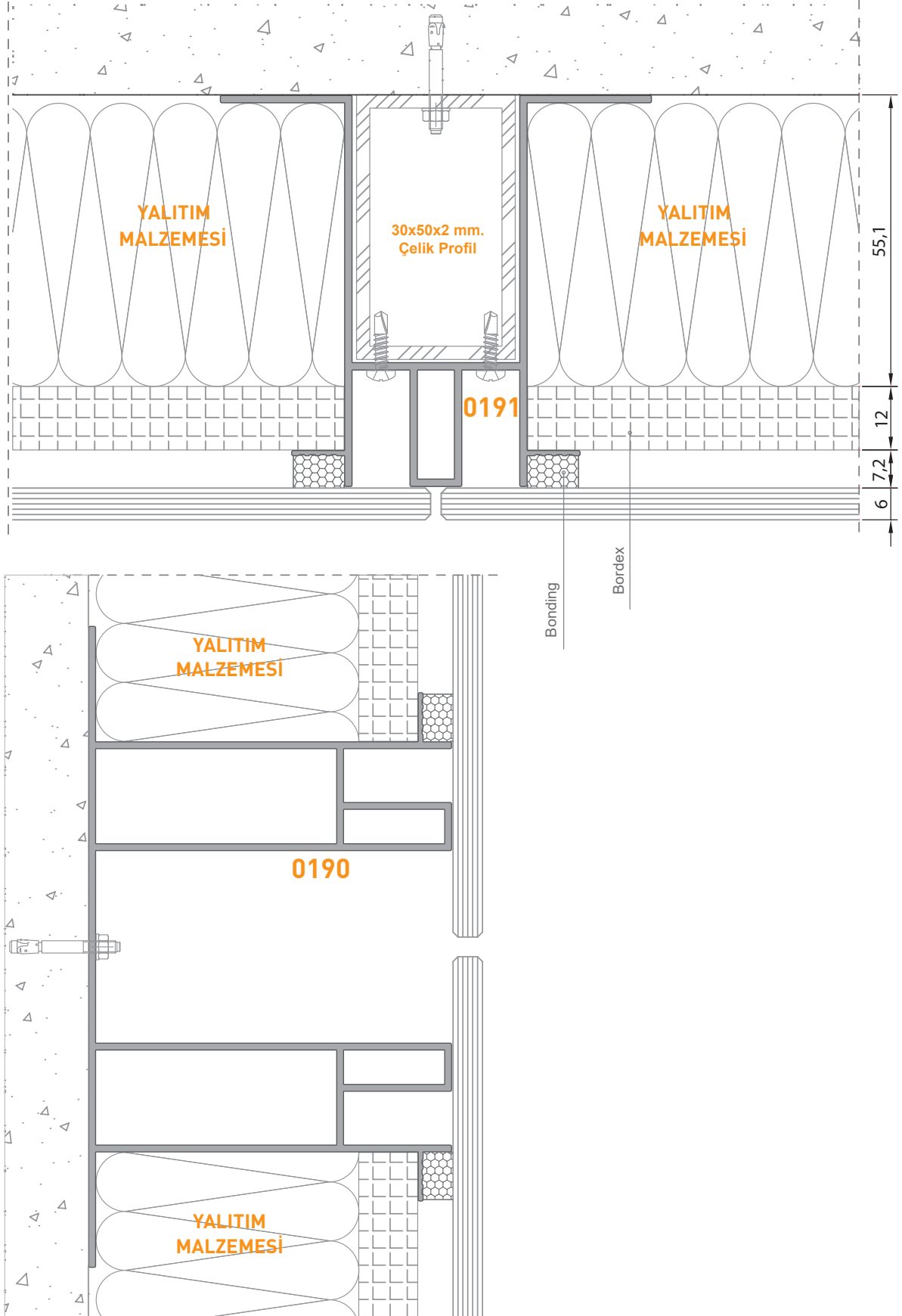

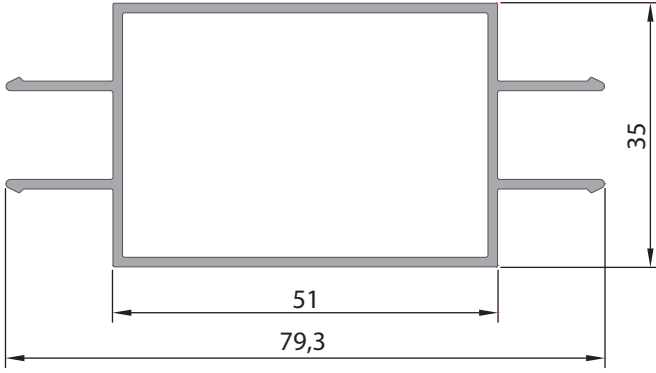
**2501**

İç Bölme Profili
Ağırlık (Kg/mt.)
0,849 Kg/mt.

**2502**

İç Bölme Profil Kapak
Ağırlık (Kg/mt.)
0,256 Kg/mt.

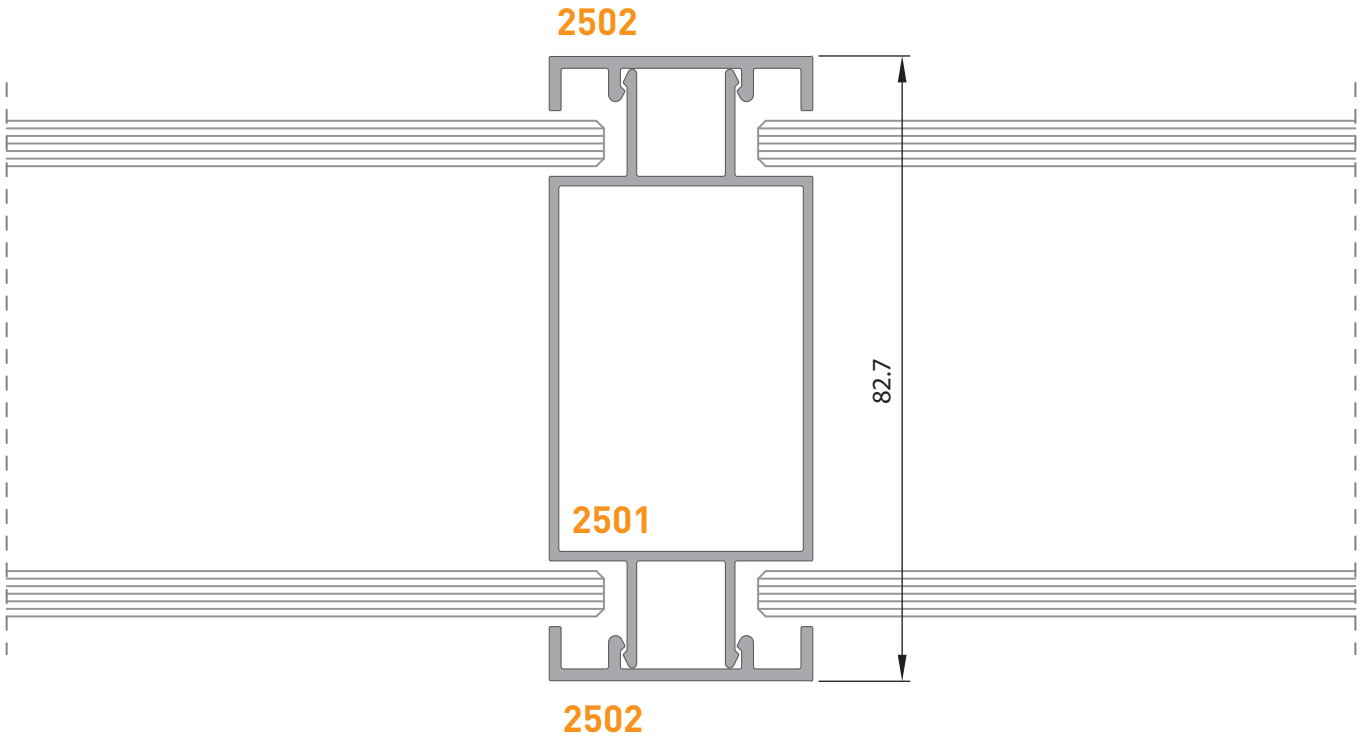

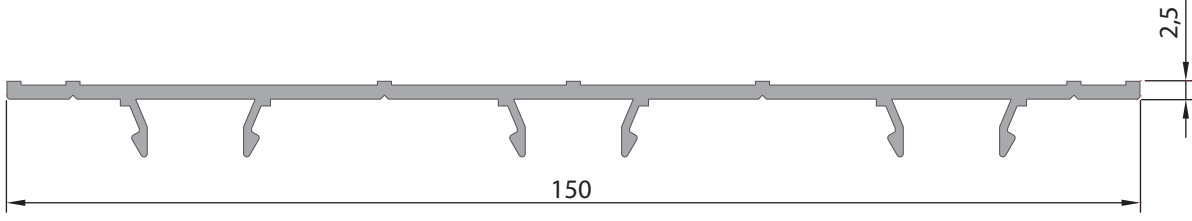
**125**

Tutucu Profil

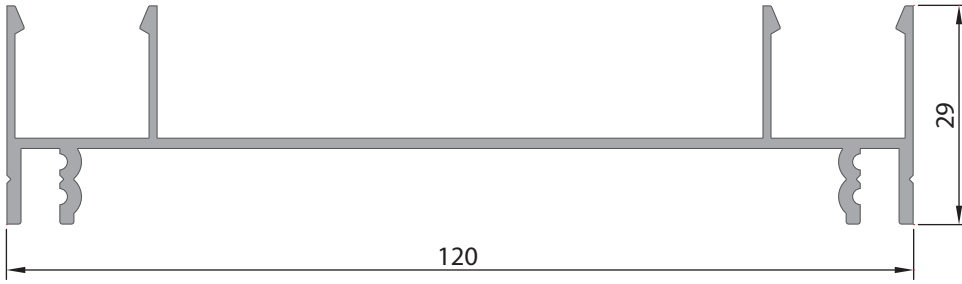
Ağırlık (Kg/mt.)
1,022 Kg/mt.**127**

Led Tutucu Profil

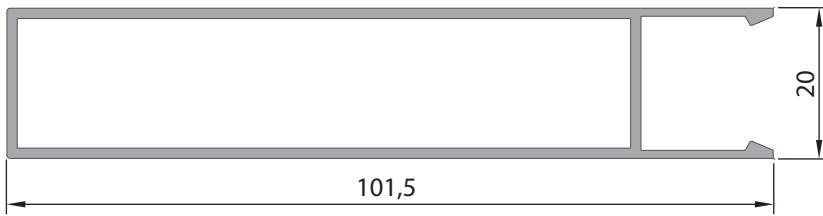
Ağırlık (Kg/mt.)
0,972 Kg/mt.**124**

Dekoratif Tavan Profili

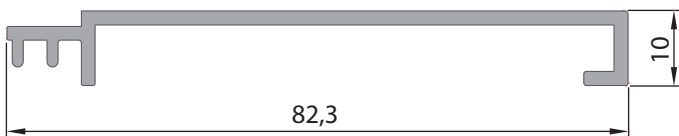
Ağırlık (Kg/mt.)
0,948 Kg/mt.**126**

Led Kapak Askı Profili

Ağırlık (Kg/mt.)
0,581 Kg/mt.

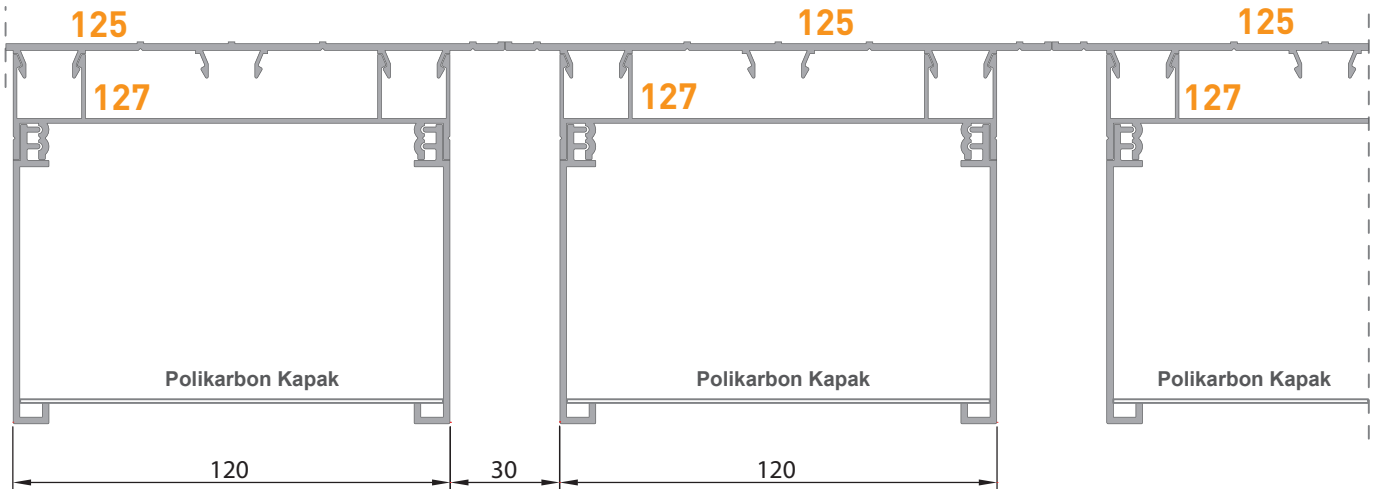
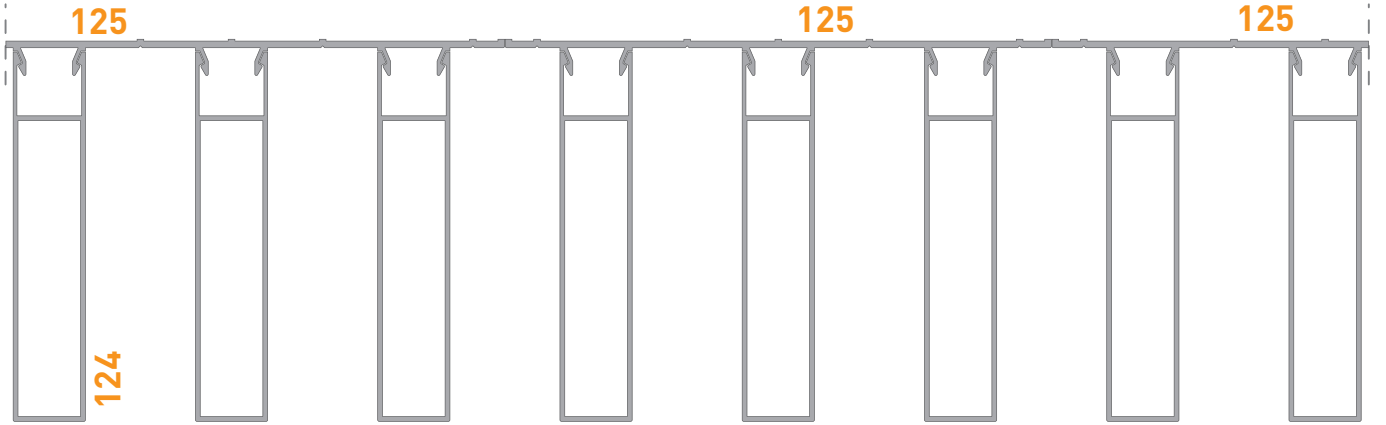
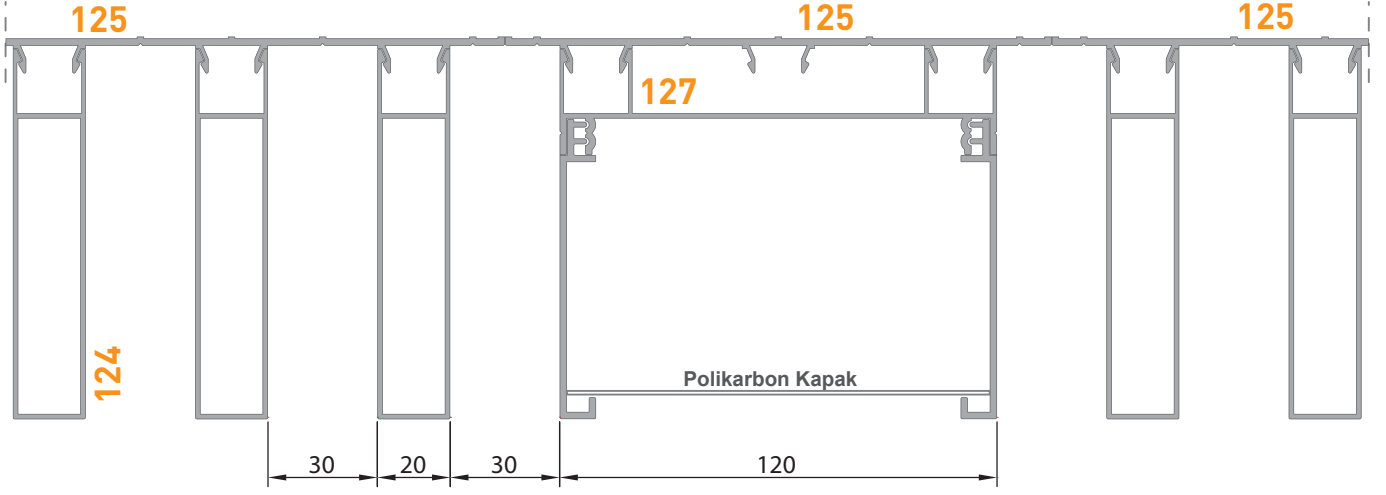

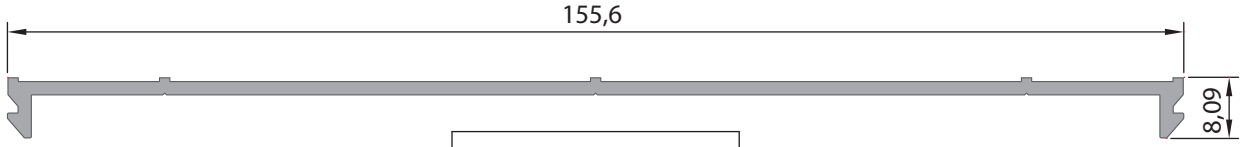
**0095**

Cephe Kapak Alt Profili

Ağırlık (Kg/mt.)
0,885 Kg/mt.**0093**

Cephe Kapak Profili

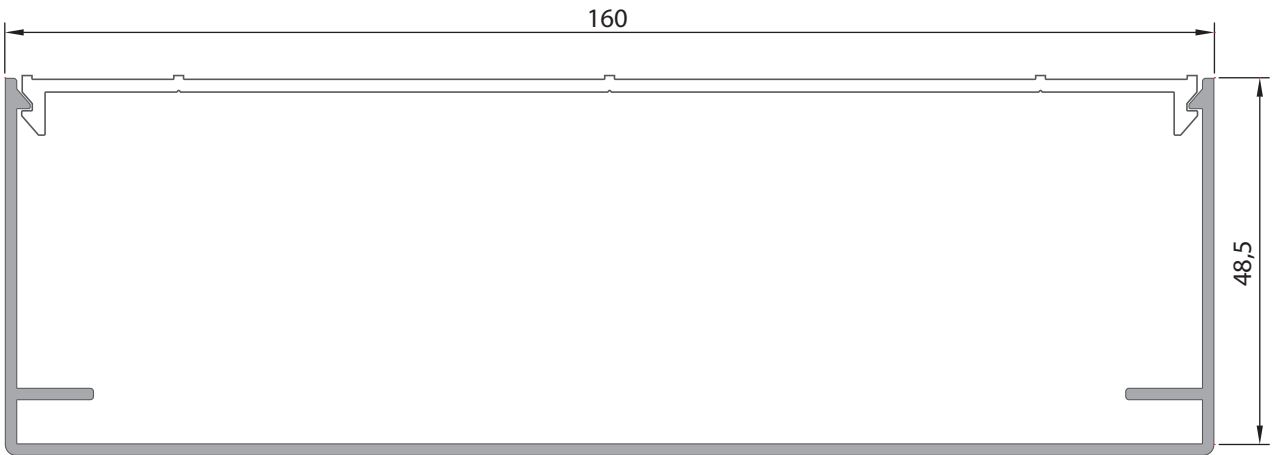
Ağırlık (Kg/mt.)
0,874 Kg/mt.**0094**

Cephe Kapak Profili

Ağırlık (Kg/mt.)
1,252 Kg/mt.

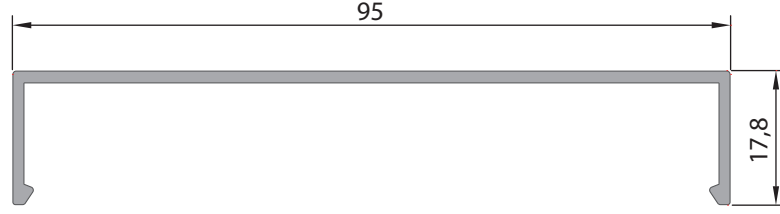
**947**

Cephe Kapak Profili

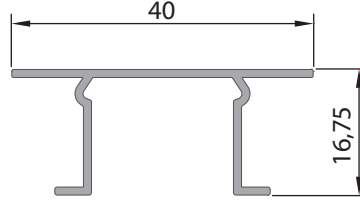
Ağırlık (Kg/mt.)
0,588 Kg/mt.**948**

Cephe Kapak Profili

Ağırlık (Kg/mt.)
0,261 Kg/mt.