

 **ALFORE**[®]

ÇELİK TAKVİYELİ CEPHE

TEKNİK ÖZELLİKLER TECHNICAL PROPERTIES

 *Plastik Hizalama*

 *Krom Hizalama*

 *Dik Bağlantı*

 *Yatay Bağlantı*

 *Kayıt Contası*

 *Adaptör Kapağı*

 *Pres Takoz*

 *Vidalı Takoz*

 *Kertme*

 *Takoz Punch*

 *Köşe Pres*

 *Testere*

 *Hızlı Yapıştırıcı*

 *Slikon*

 *Tokmak*

 *Falçata*

 *Ambalaj Miktarı*

 *Delik Çapı*

 *Yalıtım Bantı*

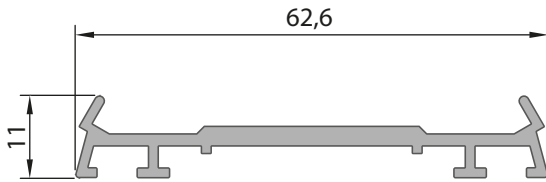
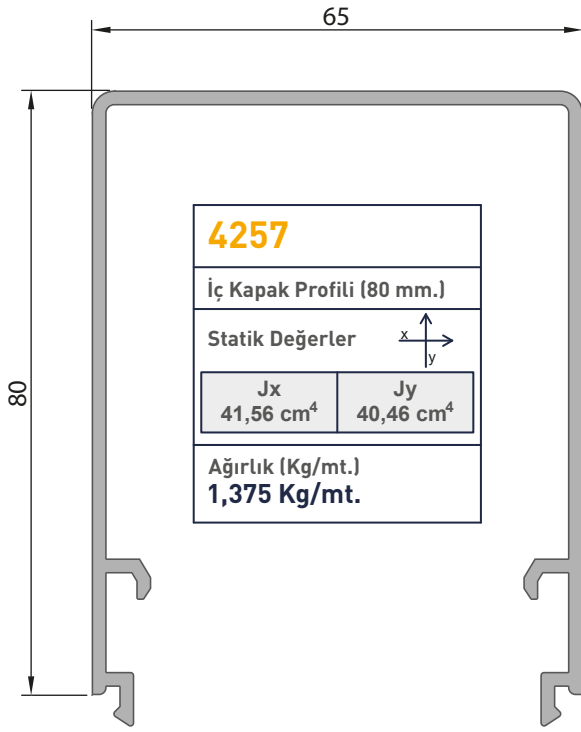







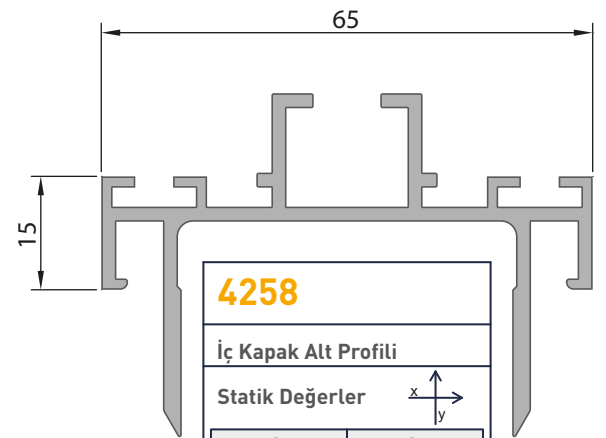
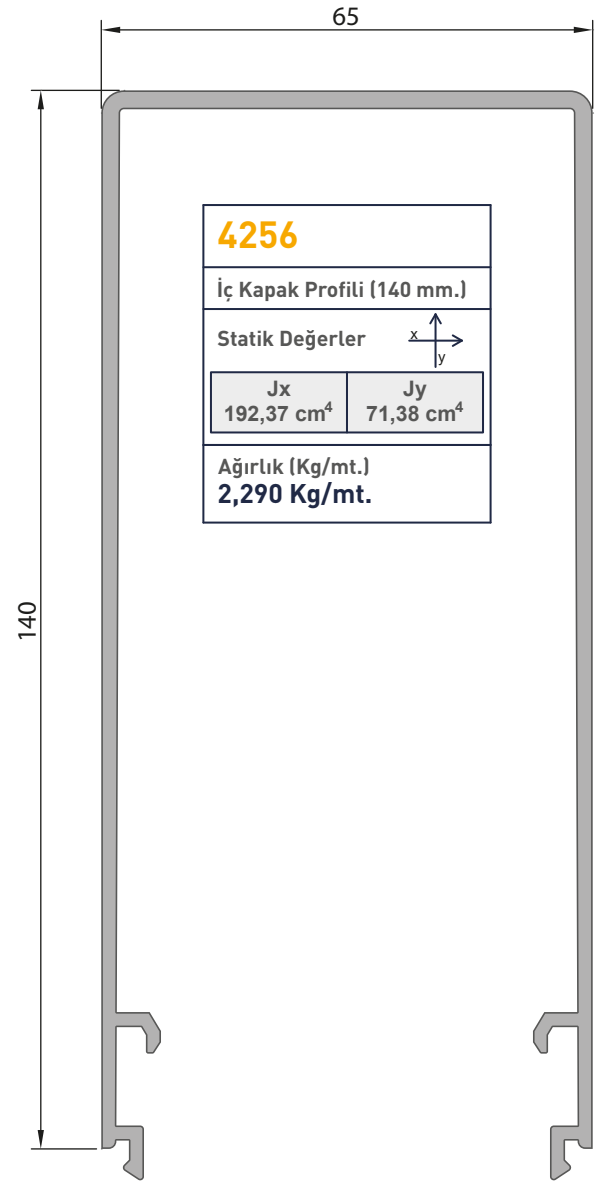

4259	
Kapak Alt Profili	
Statik Değerler $\begin{matrix} x \\ y \end{matrix}$	
Jx 0,81 cm ⁴	Jy 7,55 cm ⁴
Ağırlık (Kg/mt.) 0,536 Kg/mt.	



4260	
Kapak Profili	
Statik Değerler $\begin{matrix} x \\ y \end{matrix}$	
Jx 0,54 cm ⁴	Jy 10,26 cm ⁴
Ağırlık (Kg/mt.) 0,455 Kg/mt.	

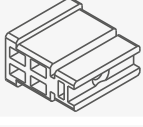

4258	
İç Kapak Alt Profili	
Statik Değerler $\begin{matrix} x \\ y \end{matrix}$	
Jx 4,41 cm ⁴	Jy 18,87 cm ⁴
Ağırlık (Kg/mt.) 1,146 Kg/mt.	

Aksesuarlar Accessories	Aksesuar Kodu Nr of Accessories	Malzeme Türü Material	Açıklama Description	Kullanıldığı Profil -----
	B4510010	EPDM	3 mm. Cephe Fiteli	218 mt. 
	B4510009	EPDM	5 mm. Cephe Fiteli	143 mt. 
	B4510014	EPDM	Kapak Altı Fiteli	169 mt. 
	B5414259	PVC	Cephe Takozu	
	B5120247	PVC	20x26 mm. PVC Kutu	6 mt.

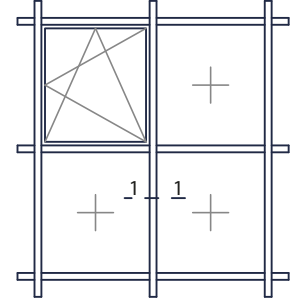

1-1 Detay

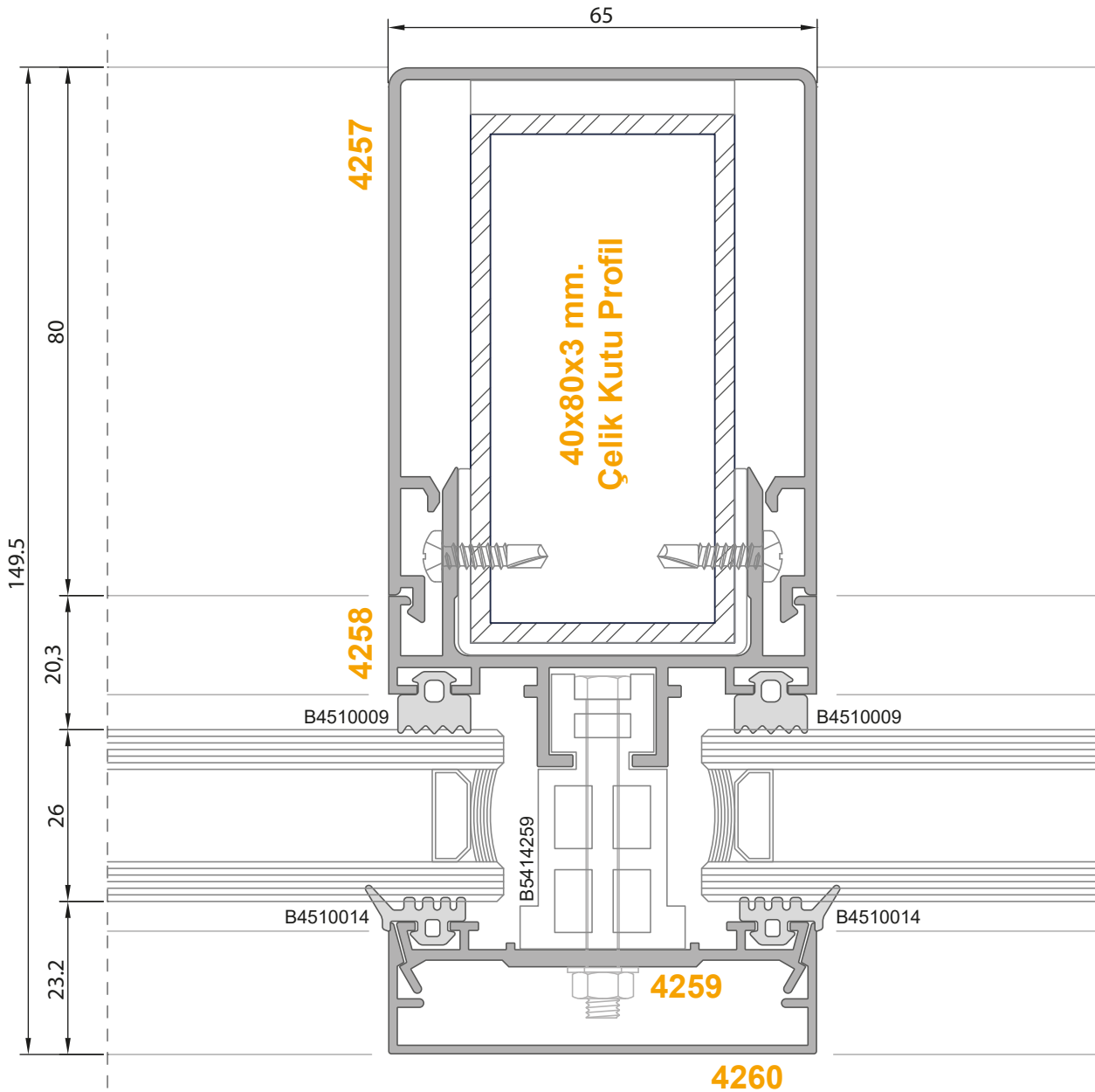

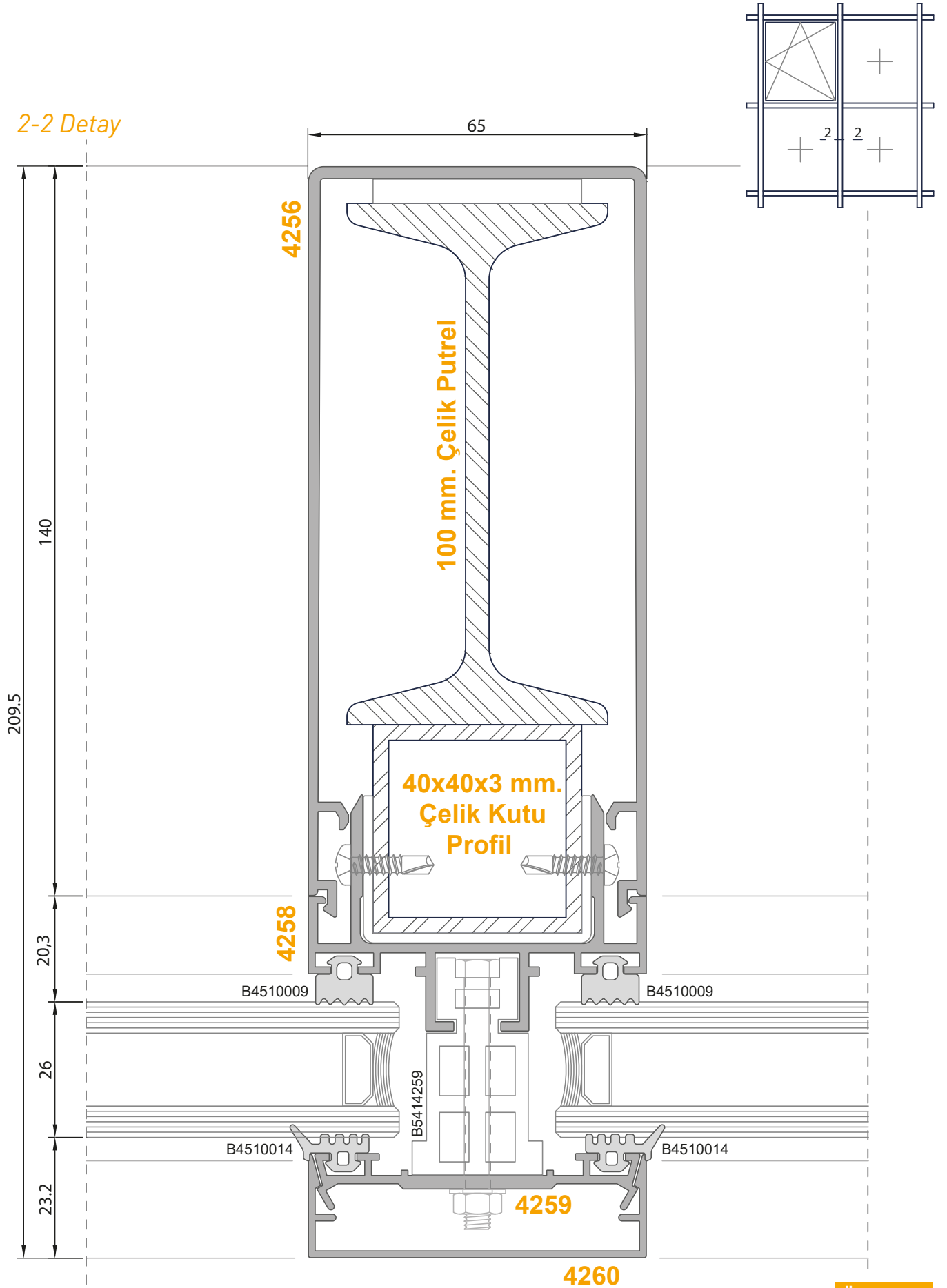

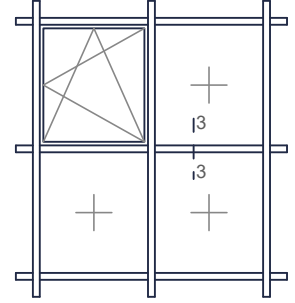

3-3 Detay

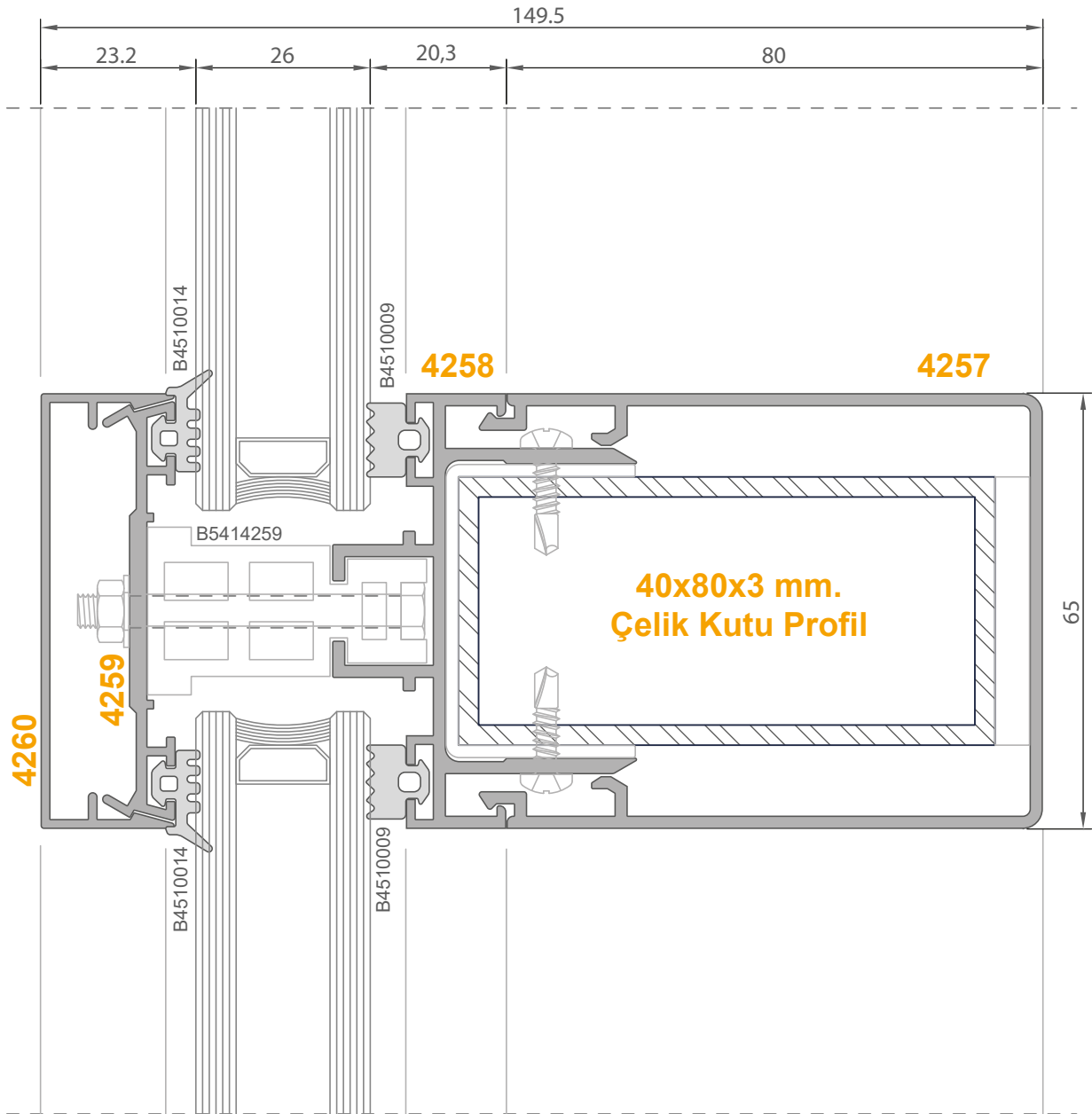

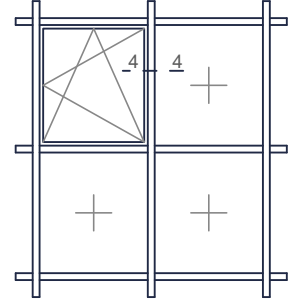

4-4 Detay

