

 **ALFORE**[®]

PANJUR PROFİLLERİ

TEKNİK ÖZELLİKLER TECHNICAL PROPERTIES

 Plastik Hizalama

 Krom Hizalama

 Dik Bağlantı

 Yatay Bağlantı

 Kayıt Contası

 Adaptör Kapağı

 Pres Takoz

 Vidalı Takoz

 Kertme

 Takoz Punch

 Köşe Pres

 Testere

 Hızlı Yapıştırıcı

 Slikon

 Tokmak

 Falçata

 Ambalaj Miktarı

 Delik Çapı

 Yalıtım Bantı

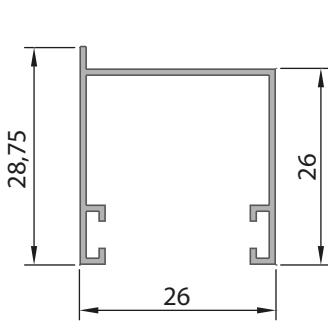

2053

Ağırlık (Kg/mt.)
0,256 Kg/mt.

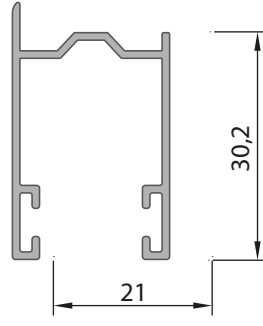

0064

Ağırlık (Kg/mt.)
0,335 Kg/mt.

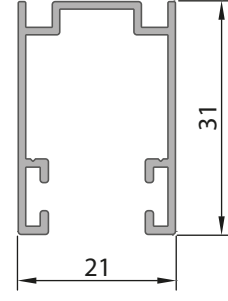

0092

Ağırlık (Kg/mt.)
0,352 Kg/mt.

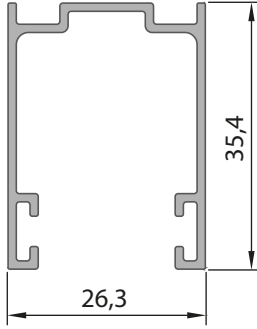

0062

Ağırlık (Kg/mt.)
0,421 Kg/mt.

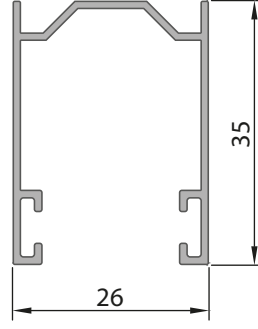

112

Ağırlık (Kg/mt.)
0,363 Kg/mt.

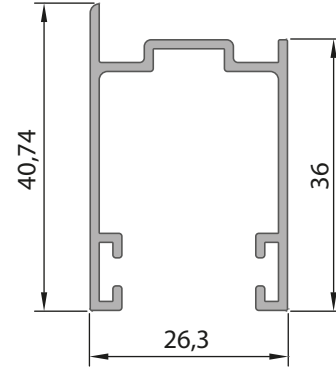

0096

Ağırlık (Kg/mt.)
0,477 Kg/mt.

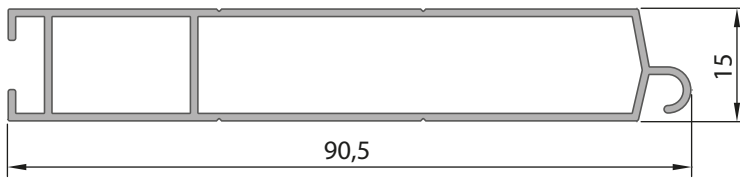

204

Ağırlık (Kg/mt.)
0,722 Kg/mt.

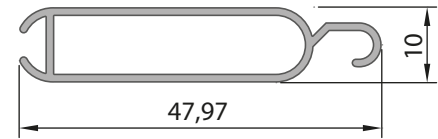

1456

Ağırlık (Kg/mt.)
0,345 Kg/mt.

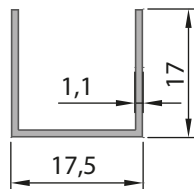

2515

Ağırlık (Kg/mt.)
0,147 Kg/mt.

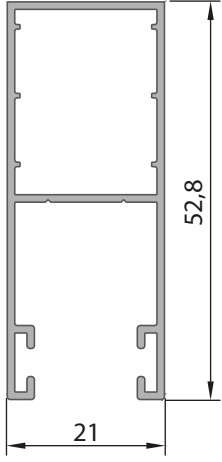

0097

Ağırlık (Kg/mt.)
0,532 Kg/mt.

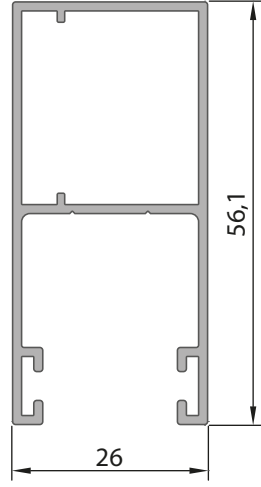

0101

Ağırlık (Kg/mt.)
0,683 Kg/mt.

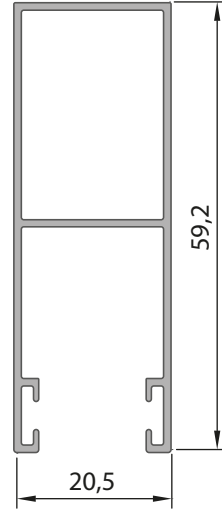

0061

Ağırlık (Kg/mt.)
0,556 Kg/mt.

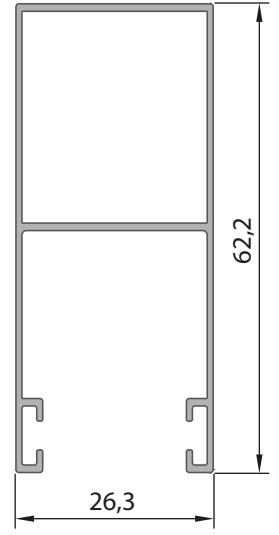

0068

Ağırlık (Kg/mt.)
0,552 Kg/mt.

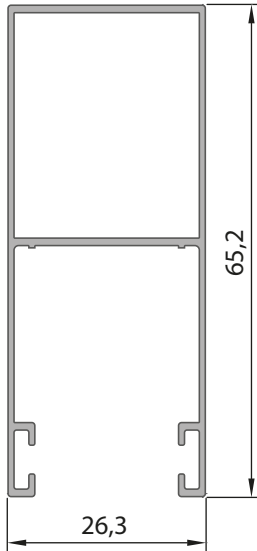

0069

Ağırlık (Kg/mt.)
0,570 Kg/mt.

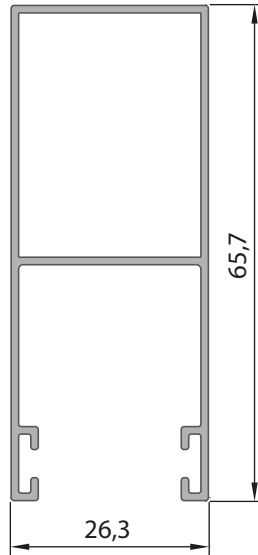

0060

Ağırlık (Kg/mt.)
0,642 Kg/mt.

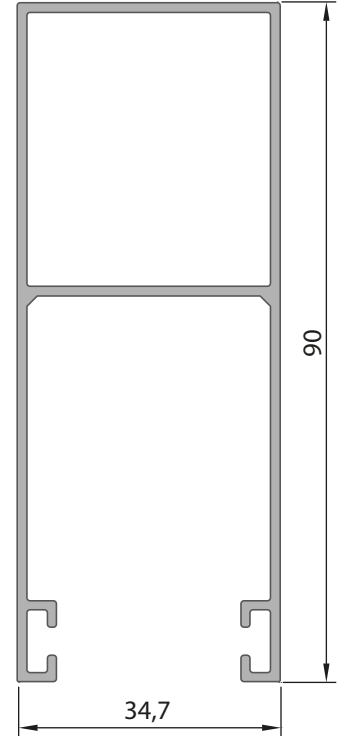

0063

Ağırlık (Kg/mt.)
1,090 Kg/mt.

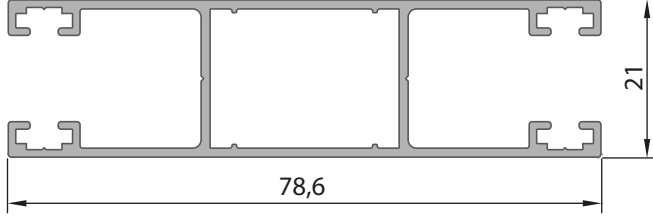

0098

Ağırlık (Kg/mt.)
0,887 Kg/mt.

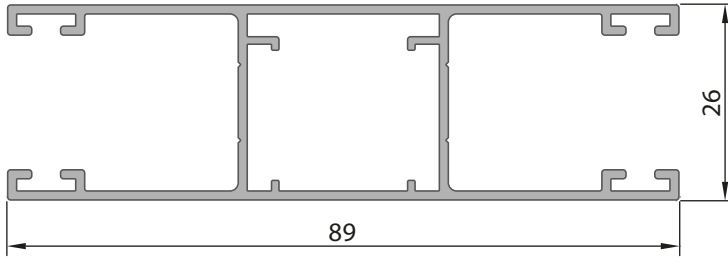

0099

Ağırlık (Kg/mt.)
1,036 Kg/mt.

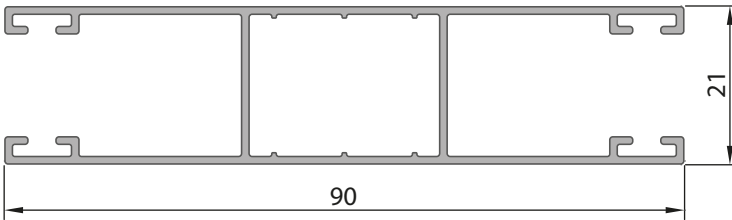

0057

Ağırlık (Kg/mt.)
0,831 Kg/mt.

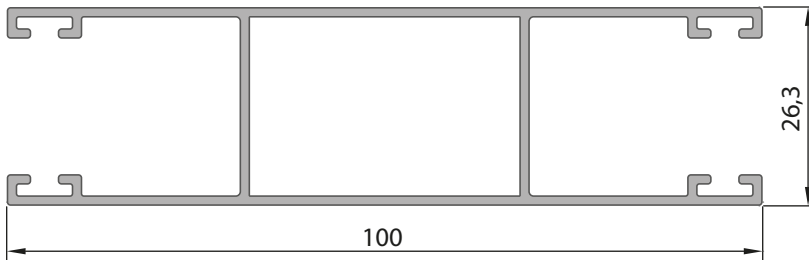

0065

Ağırlık (Kg/mt.)
1,076 Kg/mt.

