

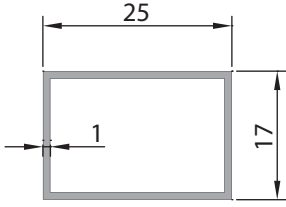

 **ALFORE**[®]

KUTU
PROFİLLERİ



**2280**

Ağırlık (Kg/mt.)
0,217 Kg/mt.

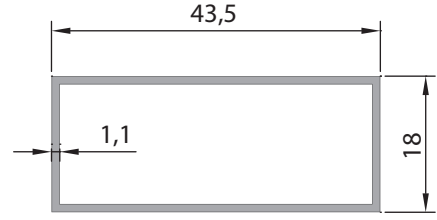
**607**

Ağırlık (Kg/mt.)
0,354 Kg/mt.

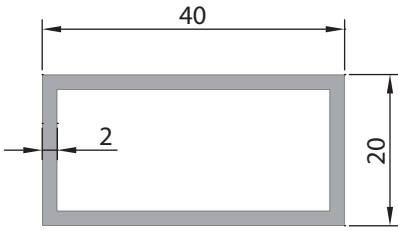
**414**

Ağırlık (Kg/mt.)
0,607 Kg/mt.

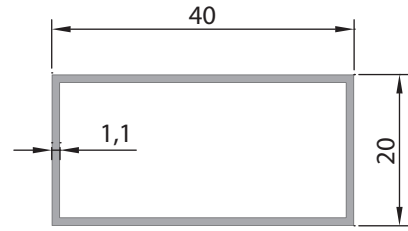
**344**

Ağırlık (Kg/mt.)
0,345 Kg/mt.

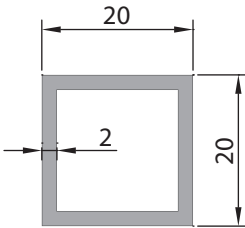
**1493**

Ağırlık (Kg/mt.)
0,391 Kg/mt.

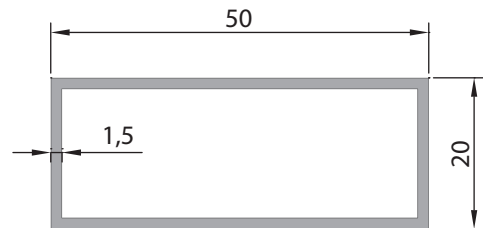
**637**

Ağırlık (Kg/mt.)
0,545 Kg/mt.

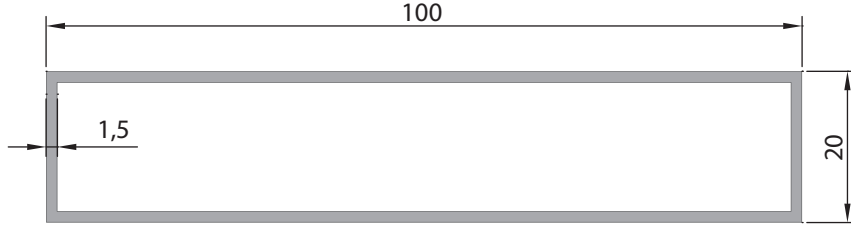
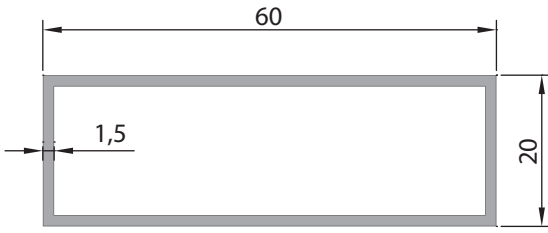
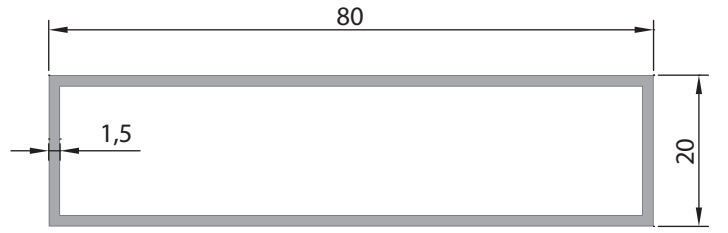
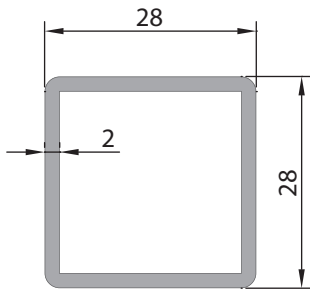
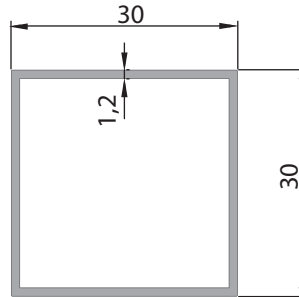
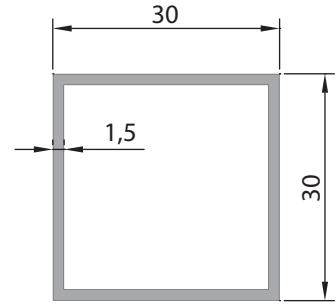
**640**Ağırlık (Kg/mt.)
0,952 Kg/mt.**639**Ağırlık (Kg/mt.)
0,626 Kg/mt.**642**Ağırlık (Kg/mt.)
0,789 Kg/mt.**293**Ağırlık (Kg/mt.)
0,555 Kg/mt.**627**Ağırlık (Kg/mt.)
0,374 Kg/mt.**426**Ağırlık (Kg/mt.)
0,464 Kg/mt.

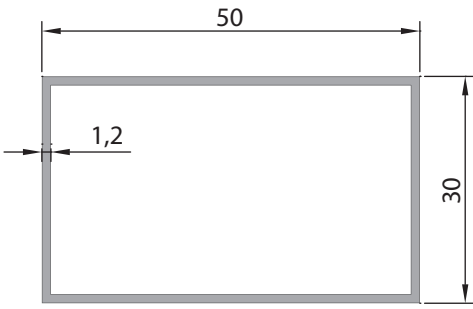
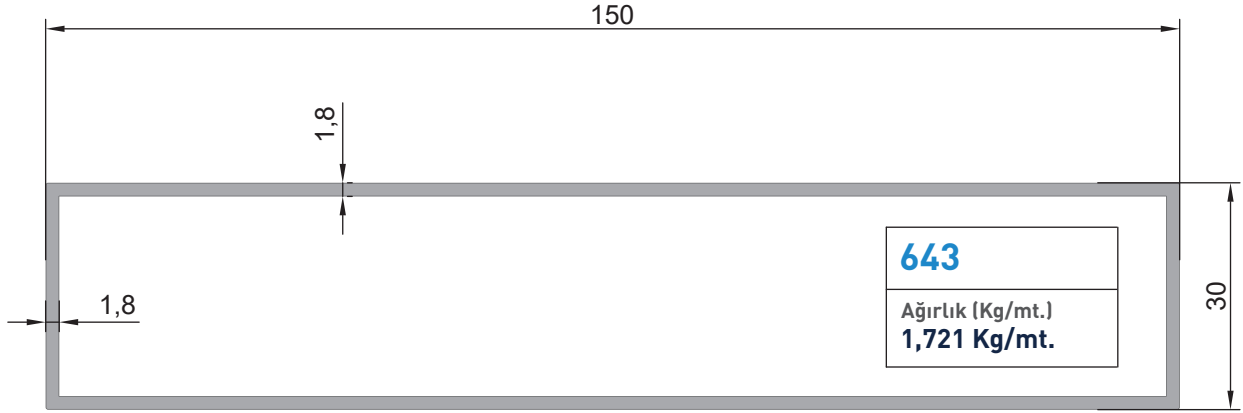

621
Ağırlık (Kg/mt.) 0,505 Kg/mt.

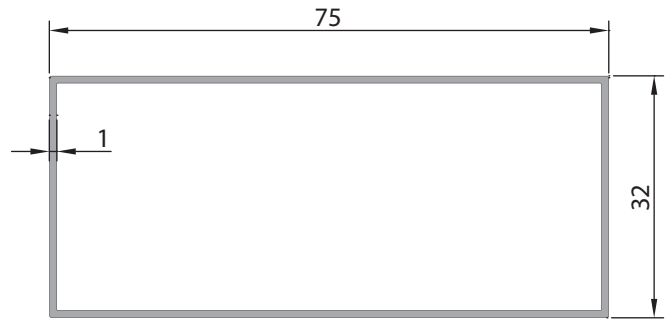

2279
Ağırlık (Kg/mt.) 0,564 Kg/mt.

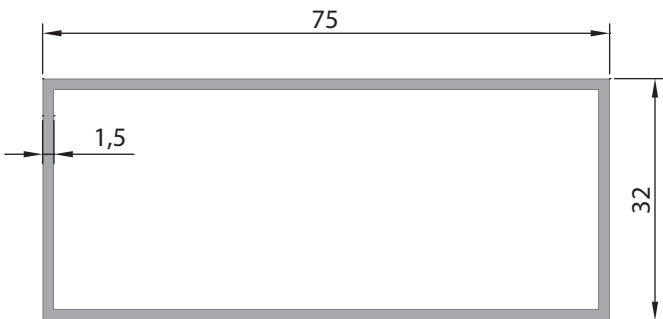

2278
Ağırlık (Kg/mt.) 0,846 Kg/mt.

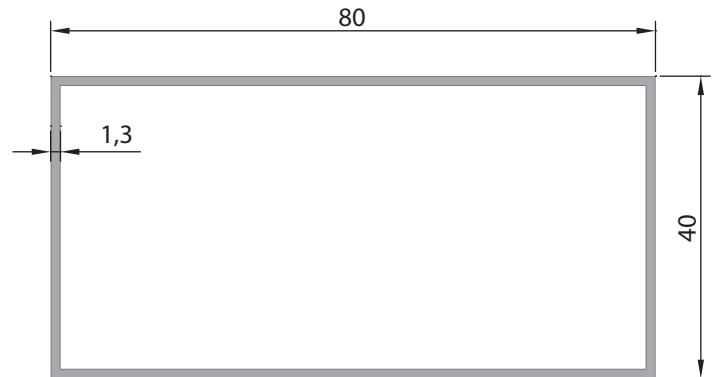

115
Ağırlık (Kg/mt.) 0,828 Kg/mt.

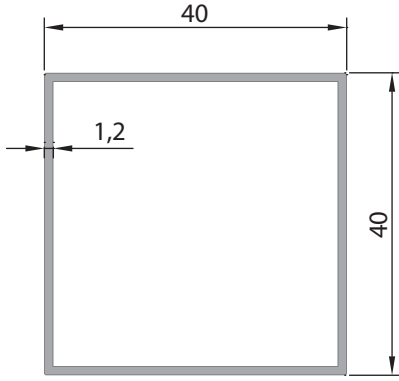
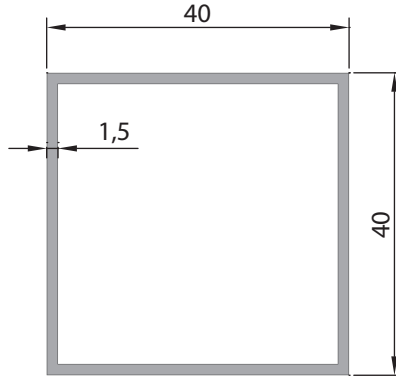
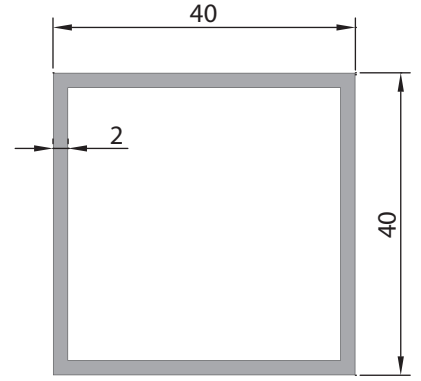
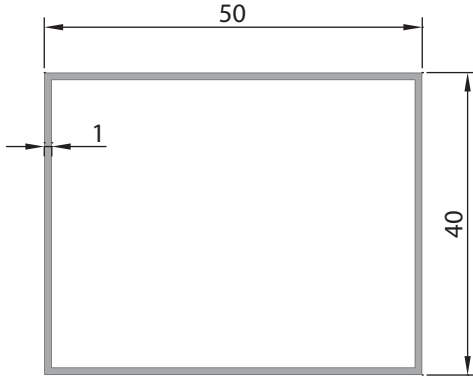
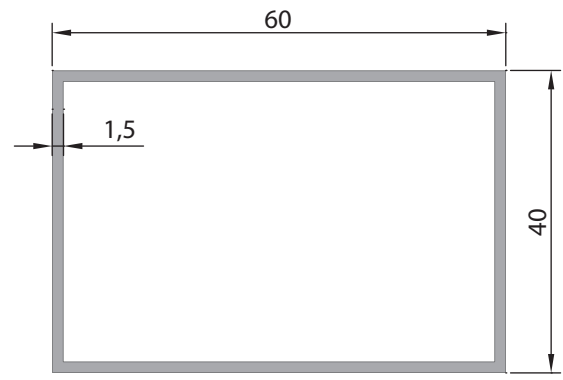
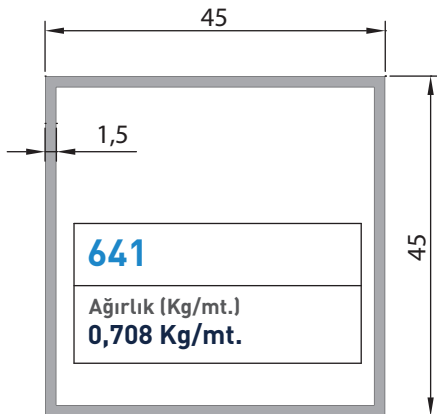
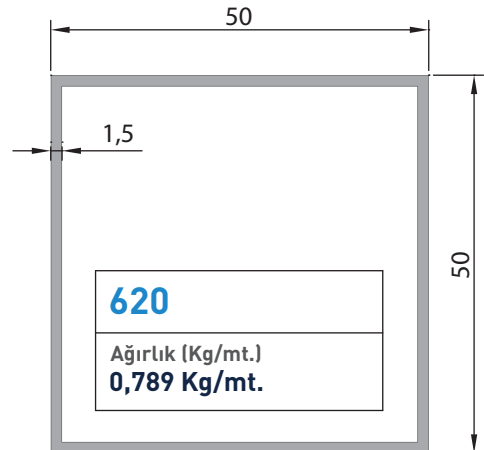
**427**Ağırlık (Kg/mt.)
0,505 Kg/mt.**0007**Ağırlık (Kg/mt.)
0,626 Kg/mt.**428**Ağırlık (Kg/mt.)
0,824 Kg/mt.**668**Ağırlık (Kg/mt.)
0,477 Kg/mt.**619**Ağırlık (Kg/mt.)
0,789 Kg/mt.**641**Ağırlık (Kg/mt.)
0,708 Kg/mt.**620**Ağırlık (Kg/mt.)
0,789 Kg/mt.

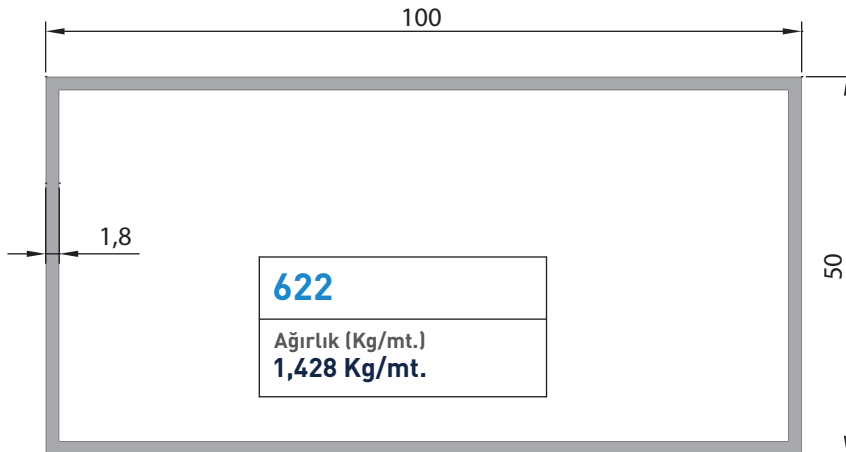
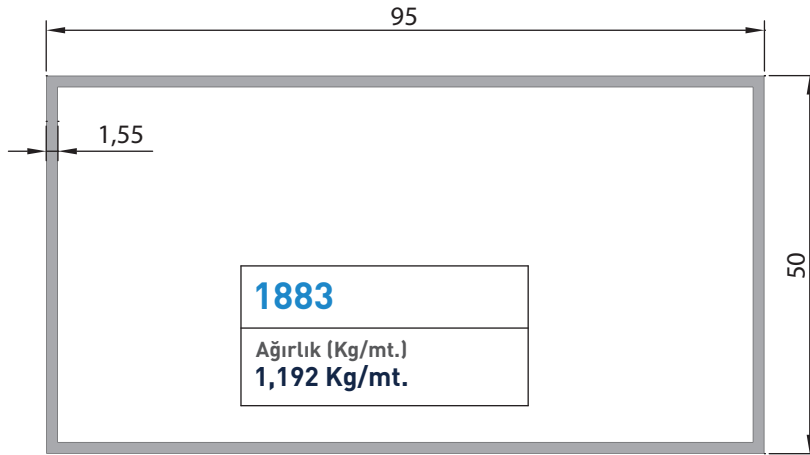
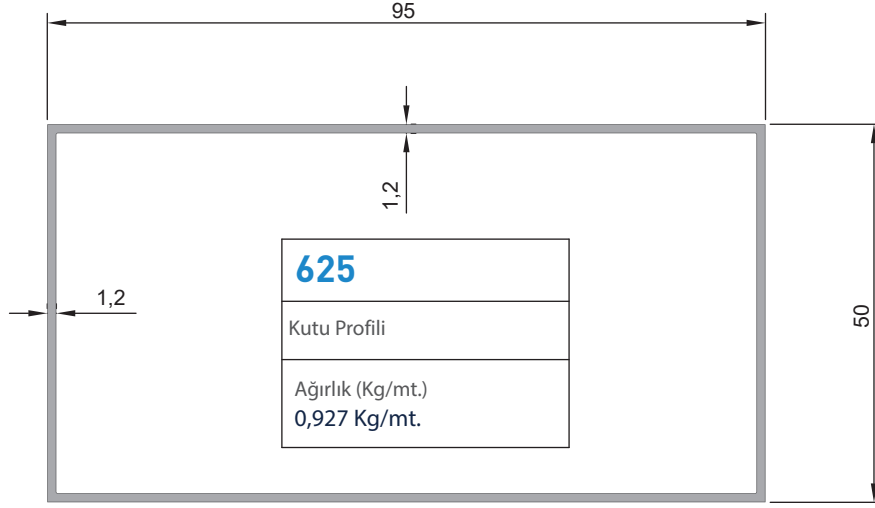

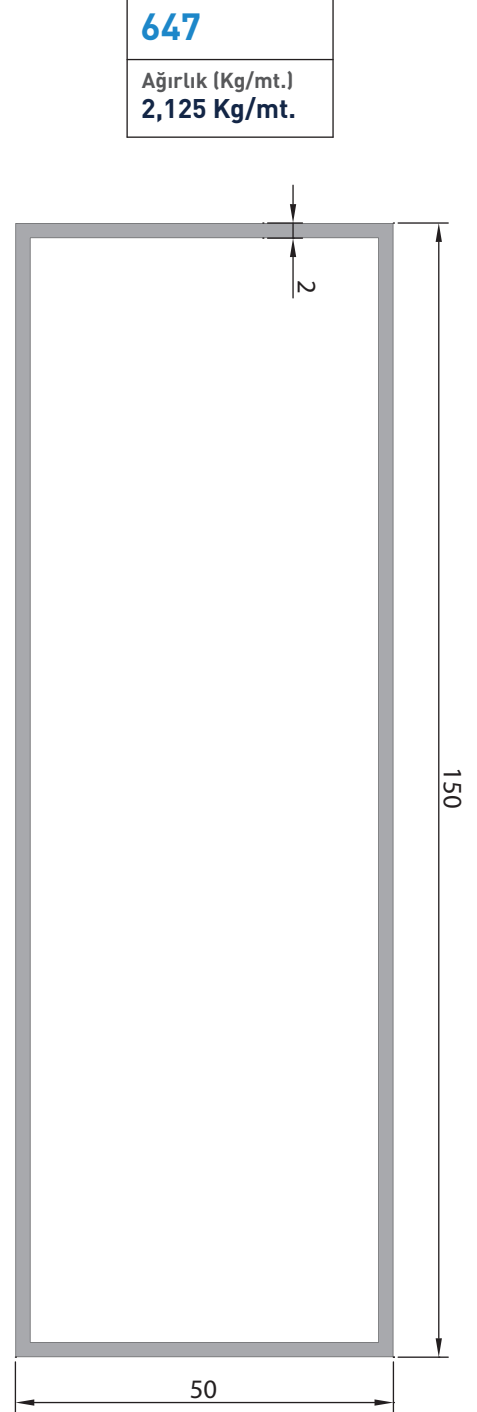
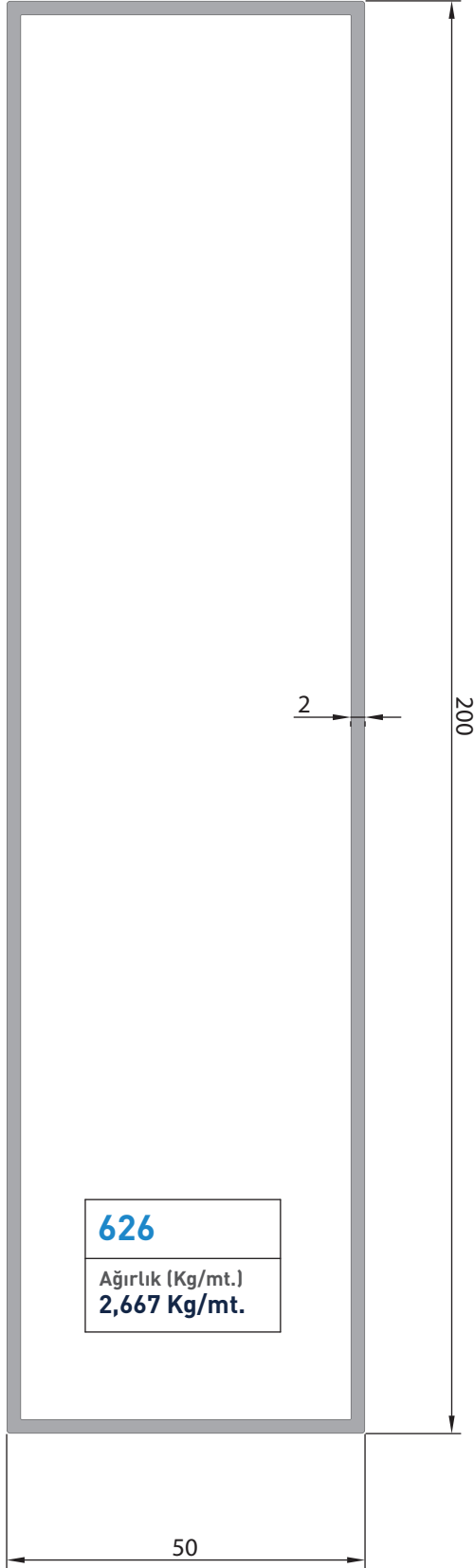

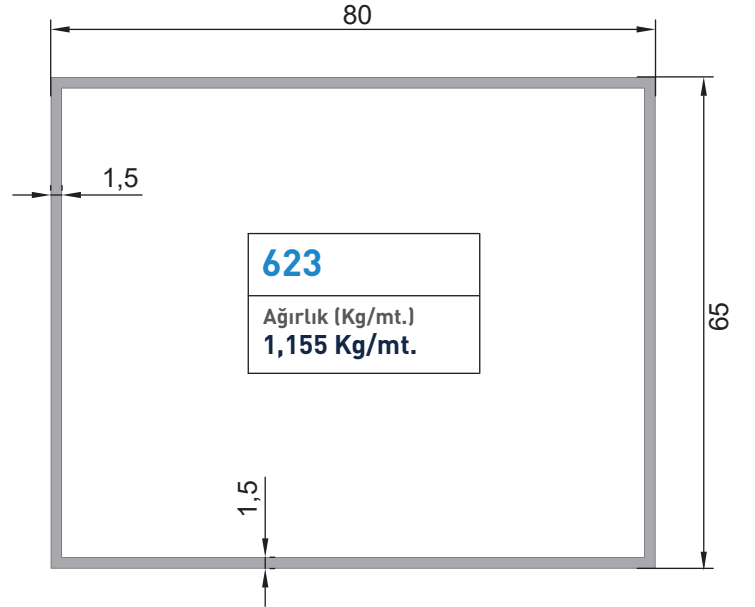
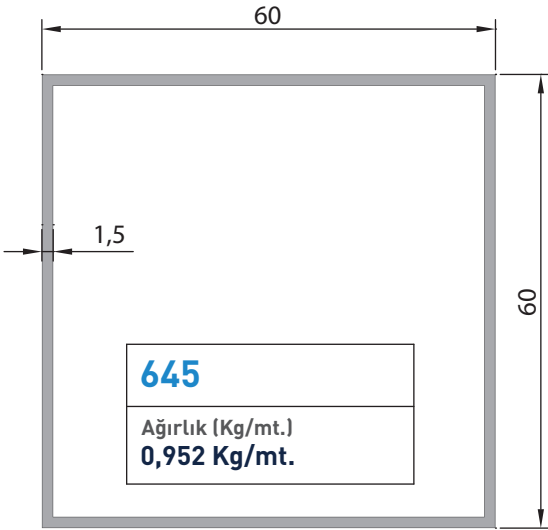
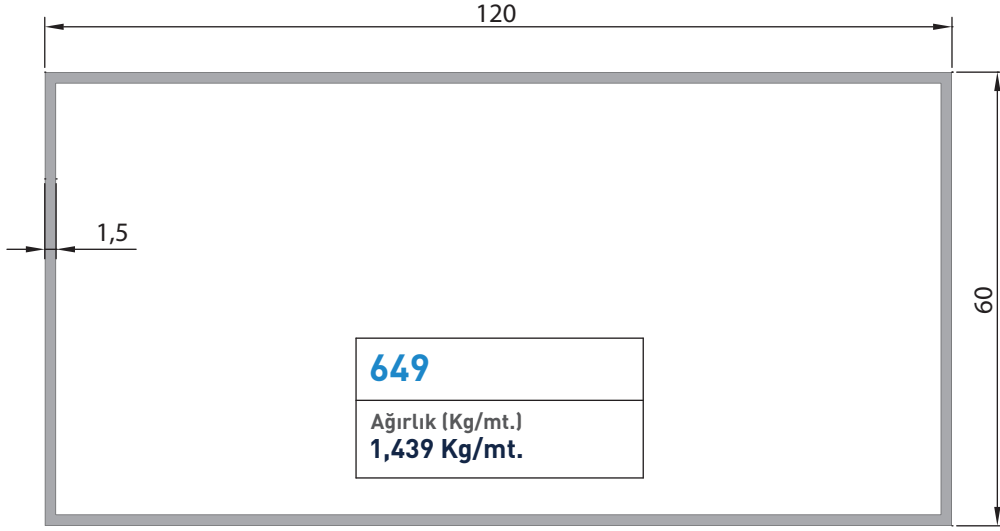

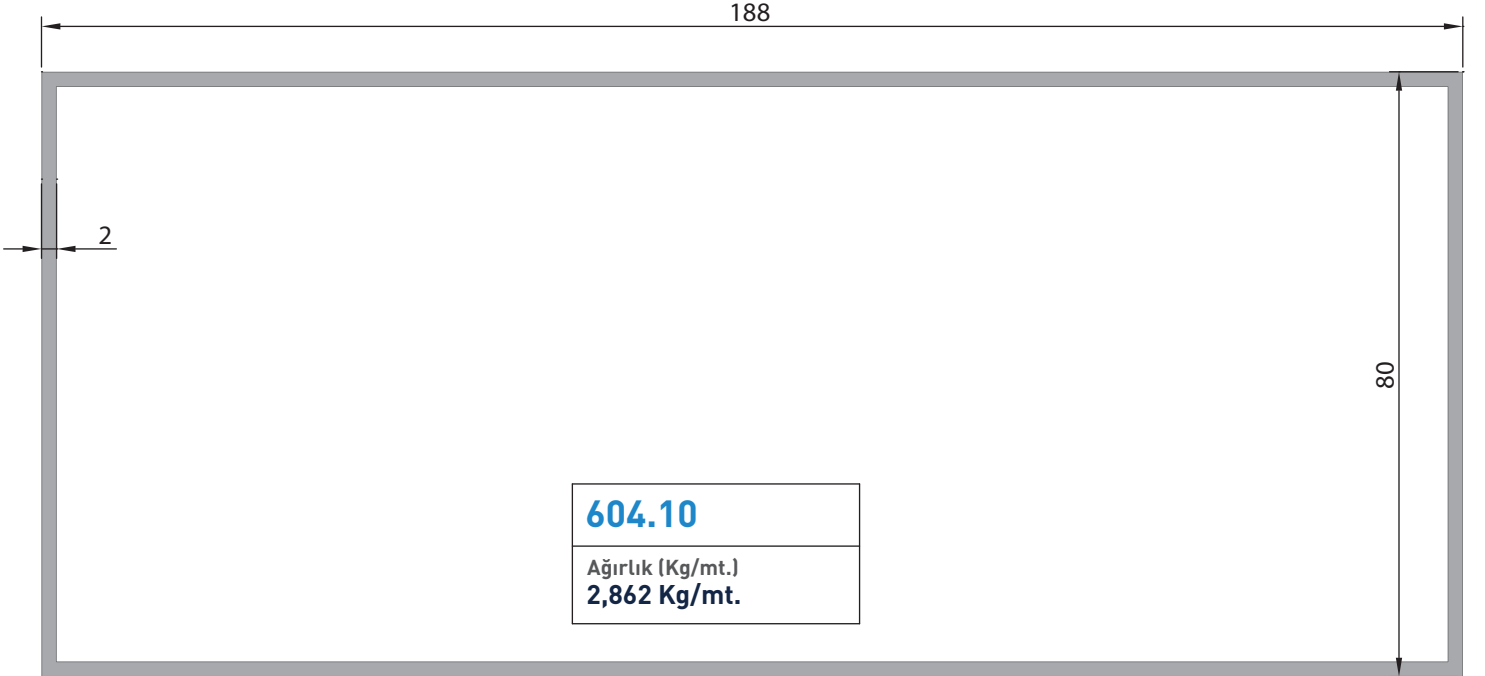
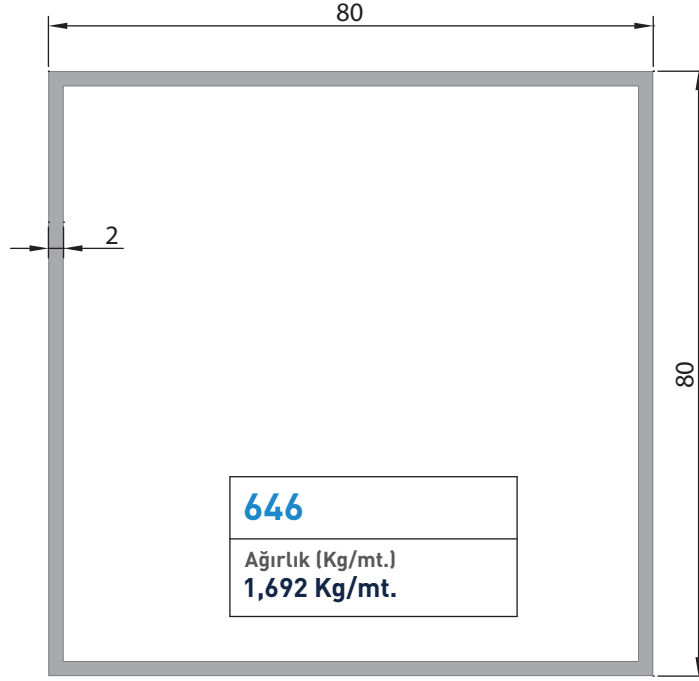

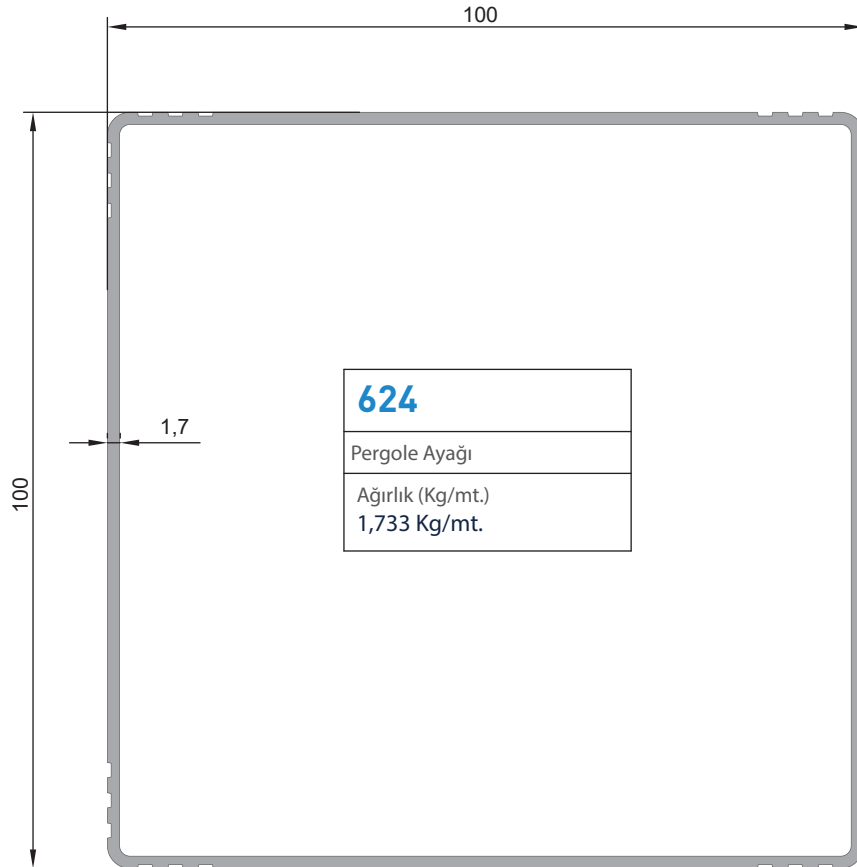
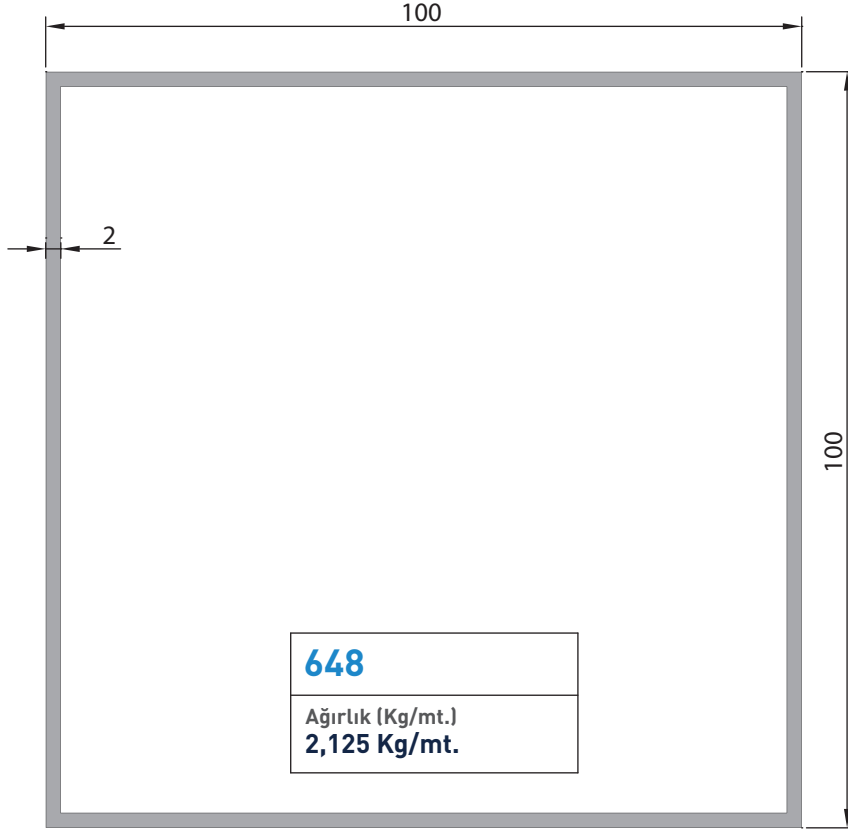

ÖZEL KUTU PROFİLLER / CUSTOM TUBE PROFILES

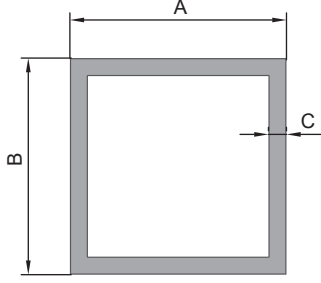

Profile Kodu Profil Nr.	A (mm.)	B (mm.)	C (mm.)	(Kg./mt)
0016	28,5	28,5	-----	2,202
438	30	18	3	0,678
655	38,1	38,1	3,18	1,202
3705	52	33	3	1,285
654	76,2	25,4	3,18	1,640
437	90	40	4	2,645
666	101,6	25,4	3	1,968
651	101,6	50,8	6,35	4,808
664	101,6	76,2	3,18	2,950
665	152,4	25,4	3	2,974
677	152,4	38,1	3,18	3,170
652	203,2	50,8	6,35	8,306

 **ALFORE®**

KUTU
PROFİLLERİ