



 **ALFORE**[®]

OFİS BÖLME
SİSTEMİ



Minimum 2 cam panel yapılabilir

Minimum 2 glass panels can be made in the system

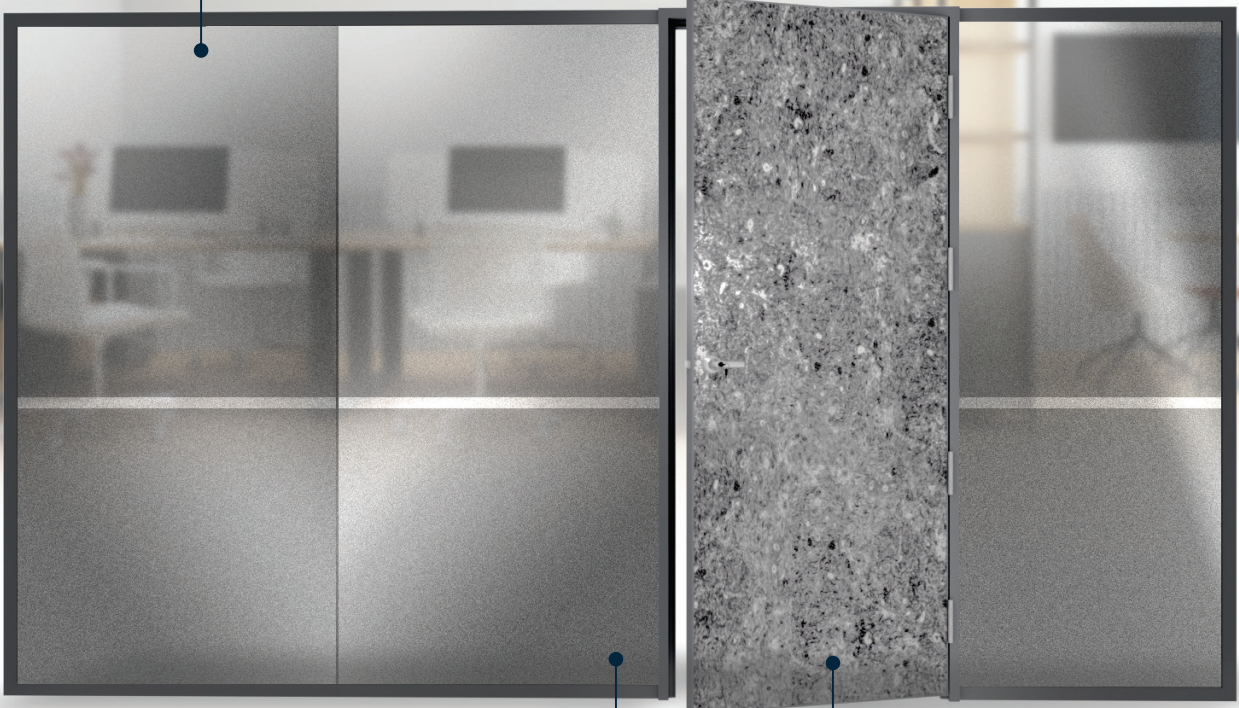

Cam panel sayısı artırılarak geniş alanlarda uygulama imkanı sunar

By increasing the number of glass panels, it is possible to apply in large areas.

***Alüminyum levha veya renkli cam opsiyonları**

**Aluminum sheet or color glass options*

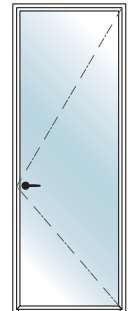

OFİS BÖLME
SİSTEMİ

 **ALFORE®**

1000 SERİSİ

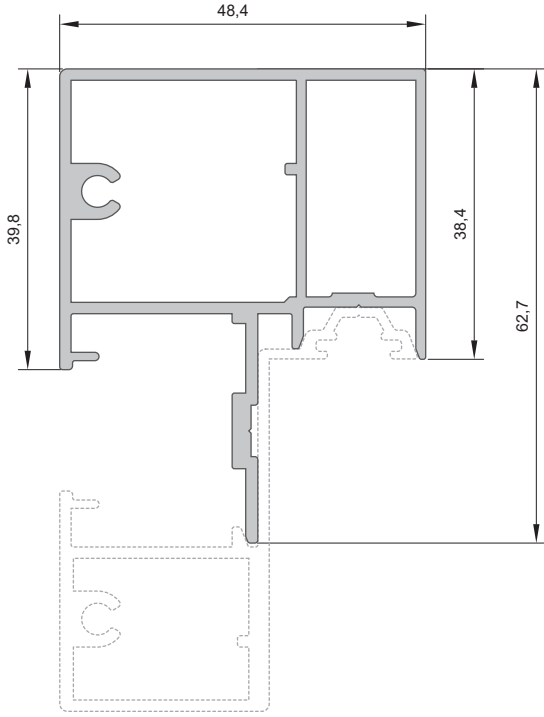
**1007**

Kasa İç Profili
Single Casing Int. Profile

Ağırlık (Kg/mt.)
Weight (Kg/mt.)
0,801 Kg/mt.

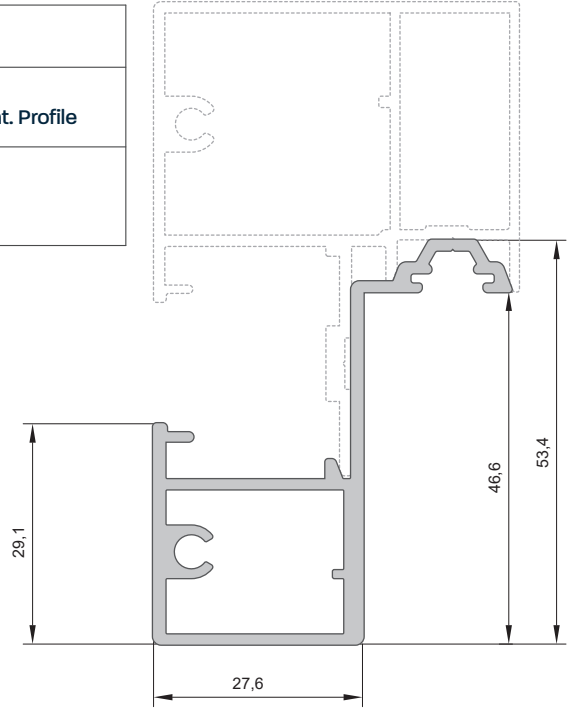
**1008**

Sabit Kasa Dış Profili
Single Casing Out Profile

Ağırlık (Kg/mt.)
Weight (Kg/mt.)
1,054 Kg/mt.

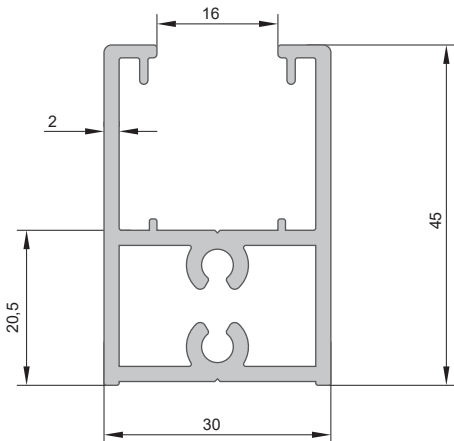
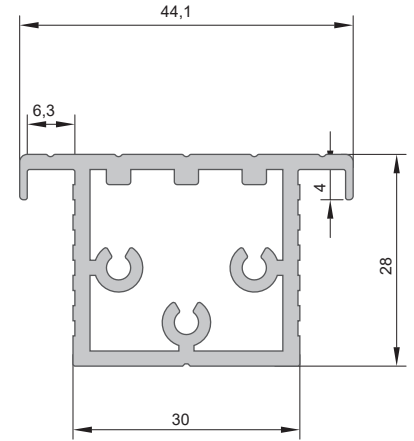
**1009**

Sabit Kasa Profili
Single Casing Profile

Ağırlık (Kg/mt.)
Weight (Kg/mt.)
0,981 Kg/mt.

1013

Cam Kapı Kanat
Glass Sash Profile

Ağırlık (Kg/mt.)
Weight (Kg/mt.)
0,920 Kg/mt.

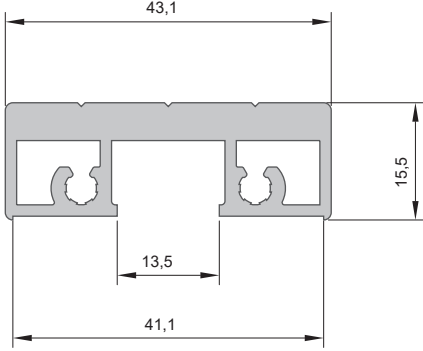
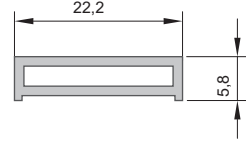
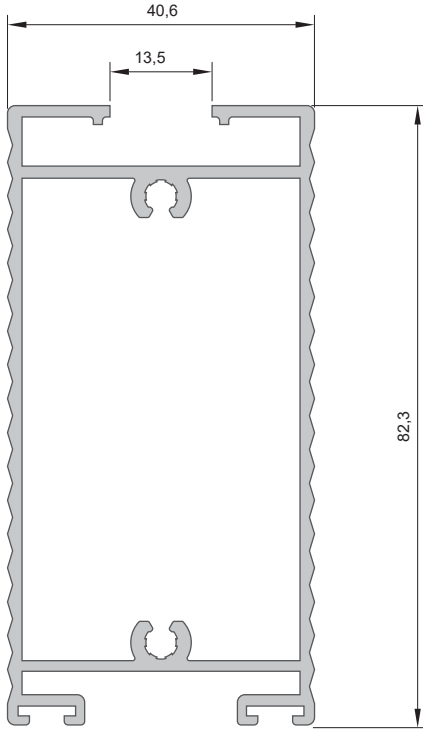
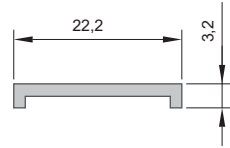
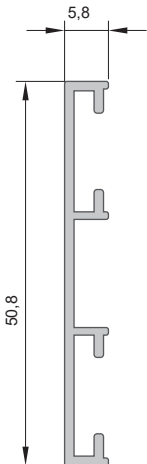
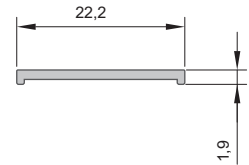
**1011****Cam Kapı Kanat**
Glass Sash ProfileAğırlık (Kg/mt.)
Weight (Kg/mt.)
0,921 Kg/mt.**LR440-14****Dekoratif Cam Çıtası**
Decorative Glazing BeadAğırlık (Kg/mt.)
Weight (Kg/mt.)
0,173 Kg/mt.**1012****Cam Kapı Baza**
Glass Sill ProfileAğırlık (Kg/mt.)
Weight (Kg/mt.)
1,326 Kg/mt.**T3324****Dekoratif Cam Çıtası**
Decorative Glazing BeadAğırlık (Kg/mt.)
Weight (Kg/mt.)
0,011 Kg/mt.**LR420-25****Dekoratif Cam Çıtası**
Decorative Glazing BeadAğırlık (Kg/mt.)
Weight (Kg/mt.)
0,266 Kg/mt.**LR440-17****Dekoratif Cam Çıtası**
Decorative Glazing BeadAğırlık (Kg/mt.)
Weight (Kg/mt.)
0,077 Kg/mt.

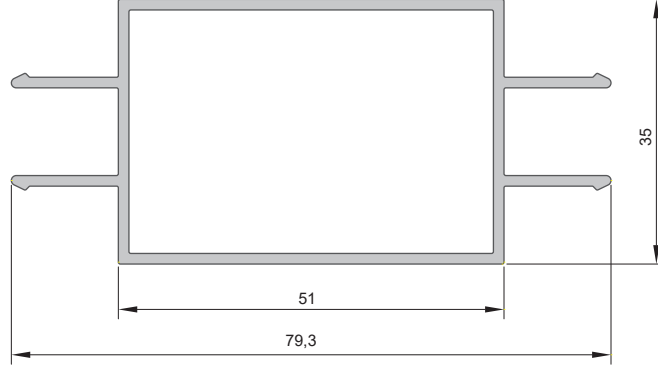
**2501**

İç Bölme Profili

Ağırlık (Kg/mt.)

Weight (Kg/mt.)

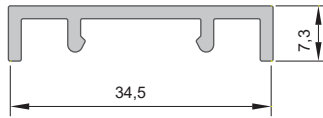







0,849 Kg/mt.**2502**

İç Bölme Profil Kapak

Ağırlık (Kg/mt.)

Weight (Kg/mt.)

0,256 Kg/mt.

Aksesuarlar Accessories	Aksesuar Kodu Nr of Accessories	Malzeme Türü Material	Açıklama Description	Kullanıldığı Profil -----
	B7410119	Alüminyum Aluminium	Hoppe HCS Kol Hoppe HCS Handle	
	B6510136	Krom Chromium	Yaprak Menteşe Leaf Hinge	LR-1007, LR-1013
	B4210026	EPDM EPDM	Kanat Contası Sash Gasket	152 mt. 
	B4410007	EPDM EPDM	1,5-2 mm. Dış Cam Fitili 1,5-2 mm. Insulating Gasket	255 mt. 
	B4612006	EPDM EPDM	Kıl Fitili Fin Seal Pile W/striping	250 mt. 
	B2410003	EPDM EPDM	20x6 mm Cam Takozu 20x6 mm. Glass Cleat	

LR 1000 OFİS BÖLME SİSTEMİ

OFFICE PARTITION SYSTEM

UYGULAMA ALTERNATİFLERİ

APPLICATION ALTERNATIVES

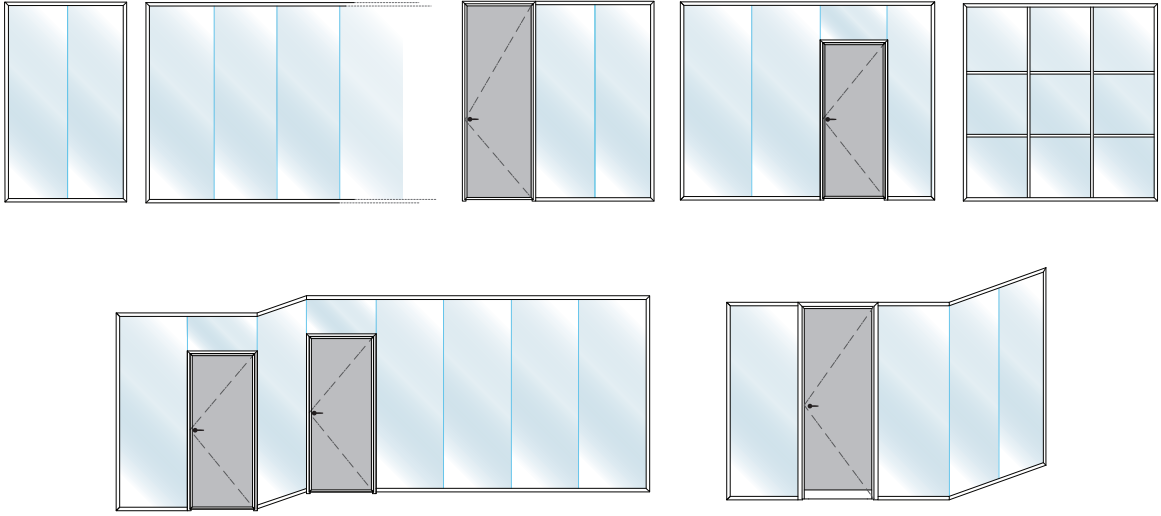

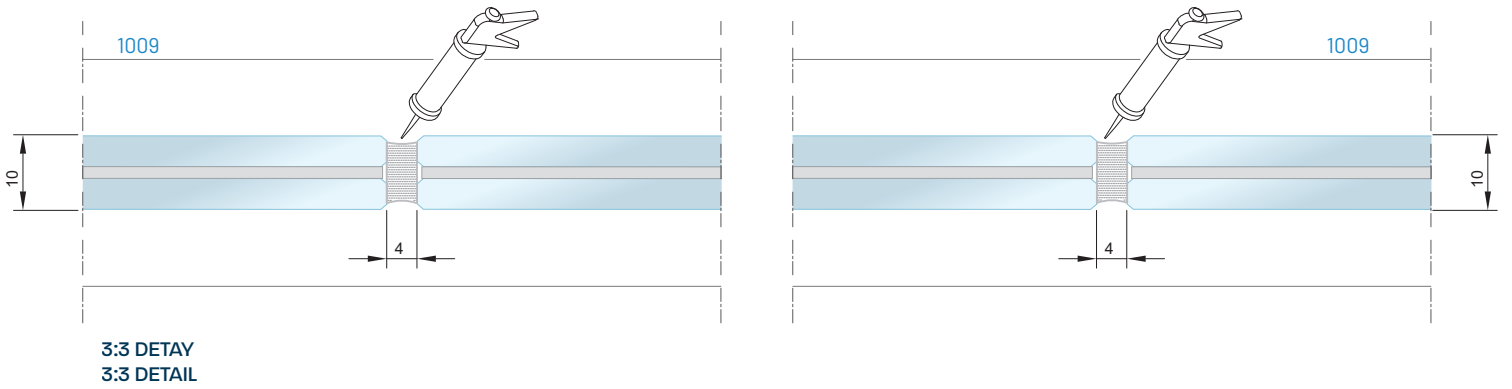
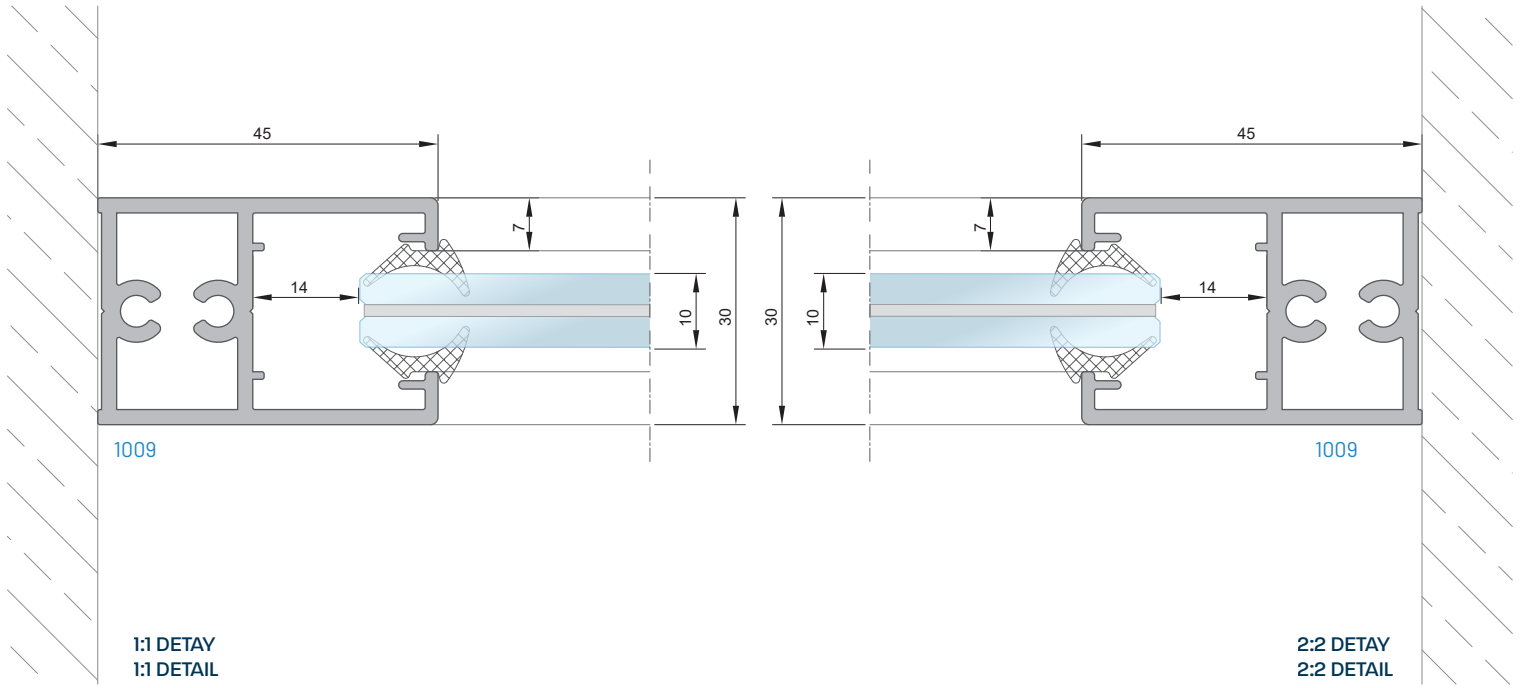
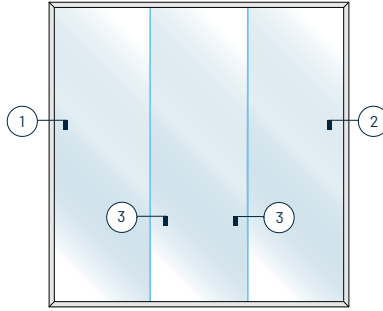

ÖLÇEK: 1:2
SCALE: 1:2

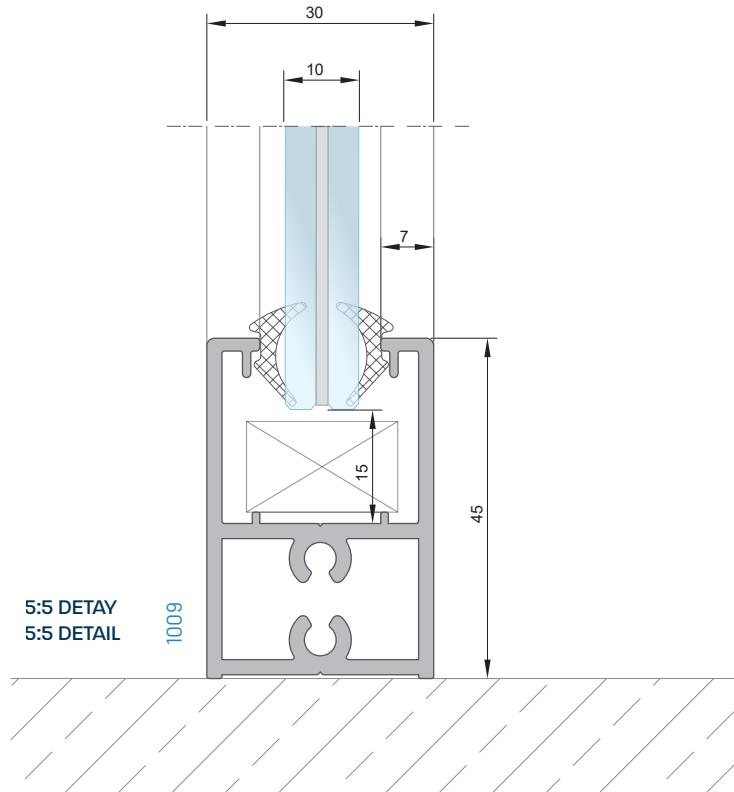
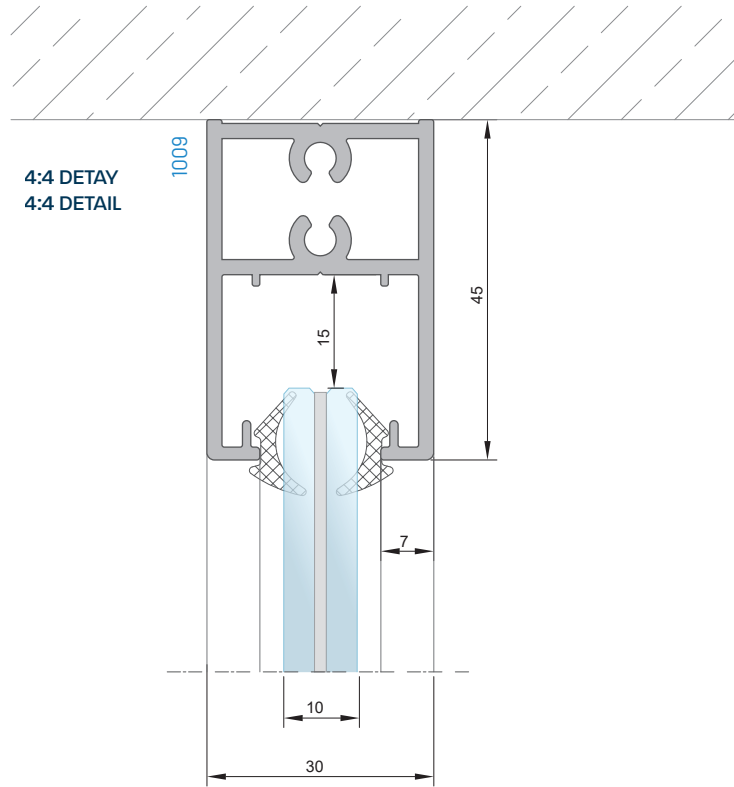
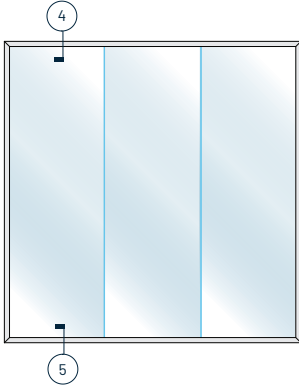

ÖLÇEK: 1:2
SCALE: 1:2

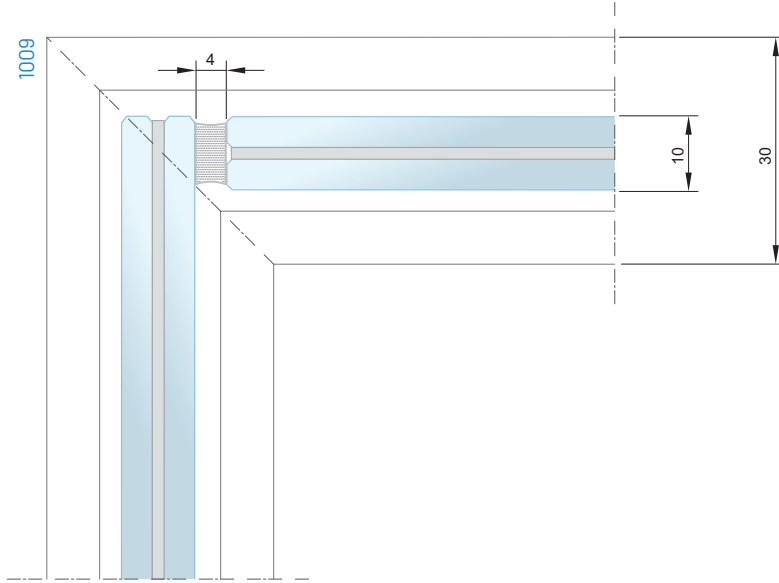
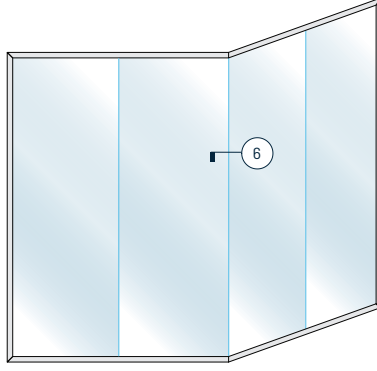

6:6 DETAY
6:6 DETAIL

ÖLÇEK: 1:2
SCALE: 1:2

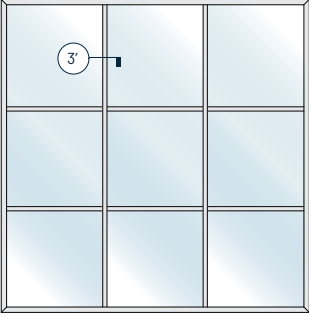

Yatay ve Düşey
Dekoratif Cam Çıtası Alternatifleri
Horizontal & Vertical
Decorative Glazing Bead Alternatives

3:3' DETAY
3:3' DETAIL

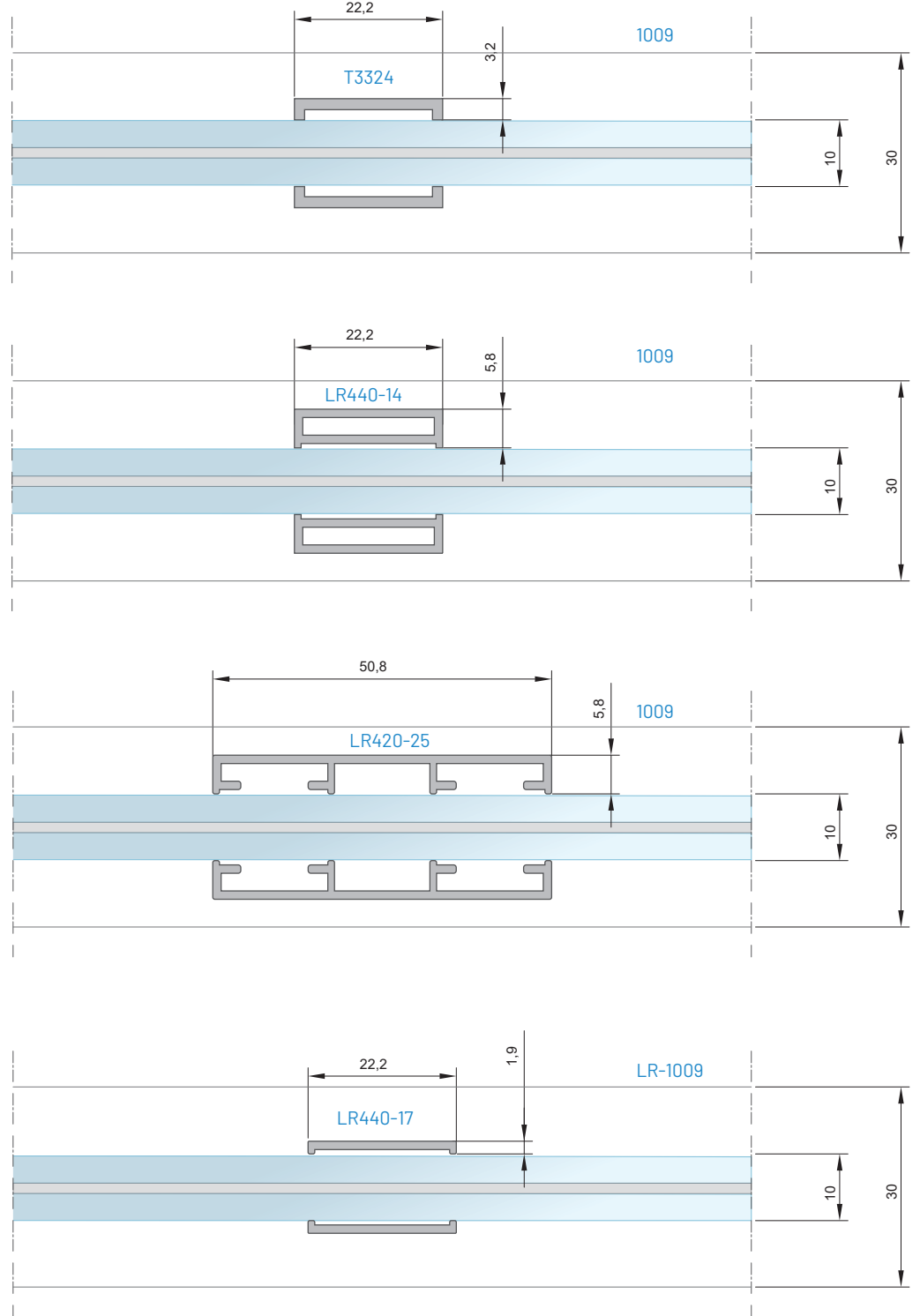

ÖLÇEK: 1:2
SCALE: 1:2

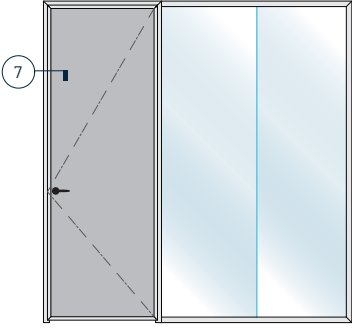

Dış Görünüş / Exterior View

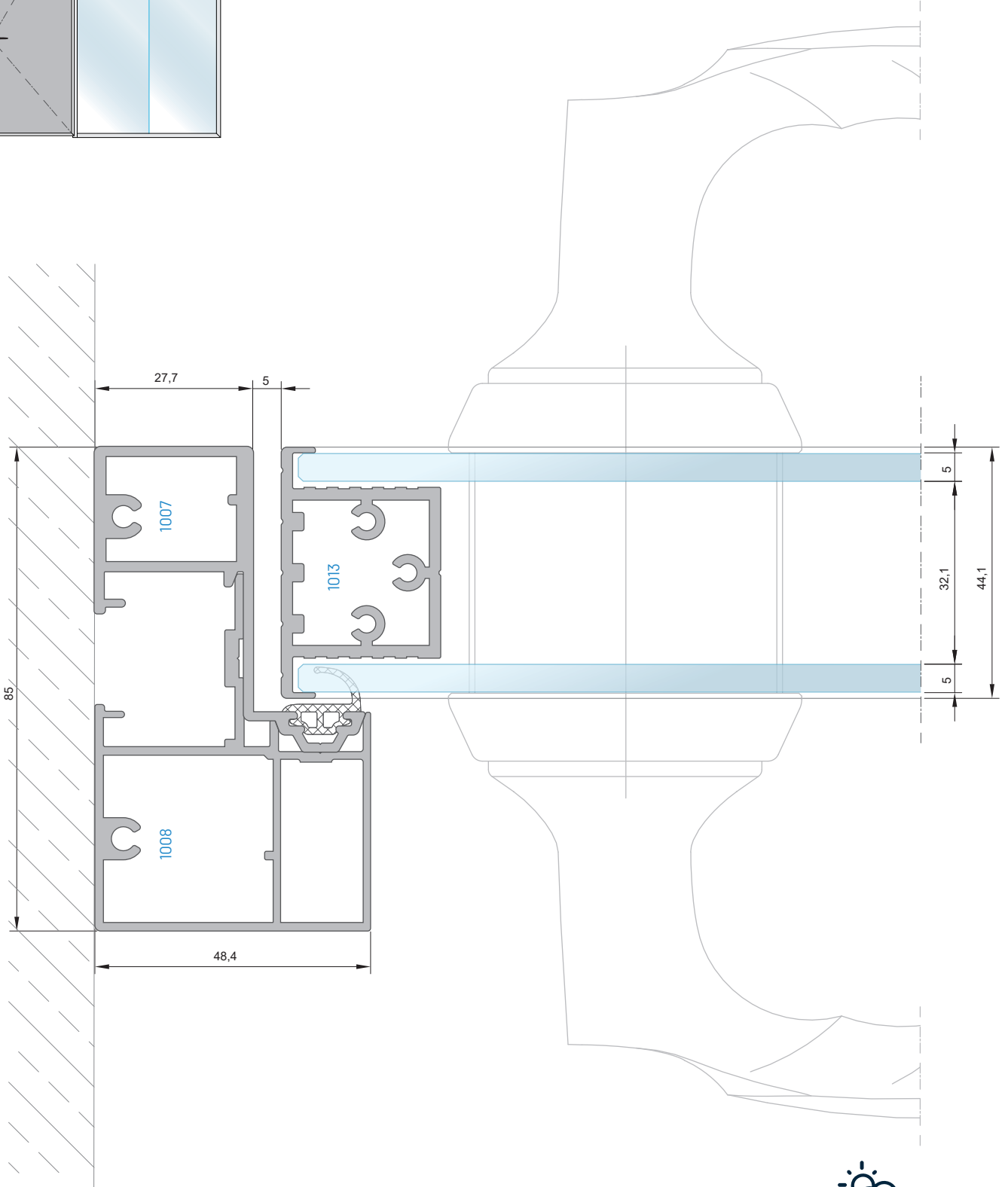

7:7 DETAY
7:7 DETAIL



ÖLÇEK: 1:2
SCALE: 1:2

Dış Görünüş / Exterior View

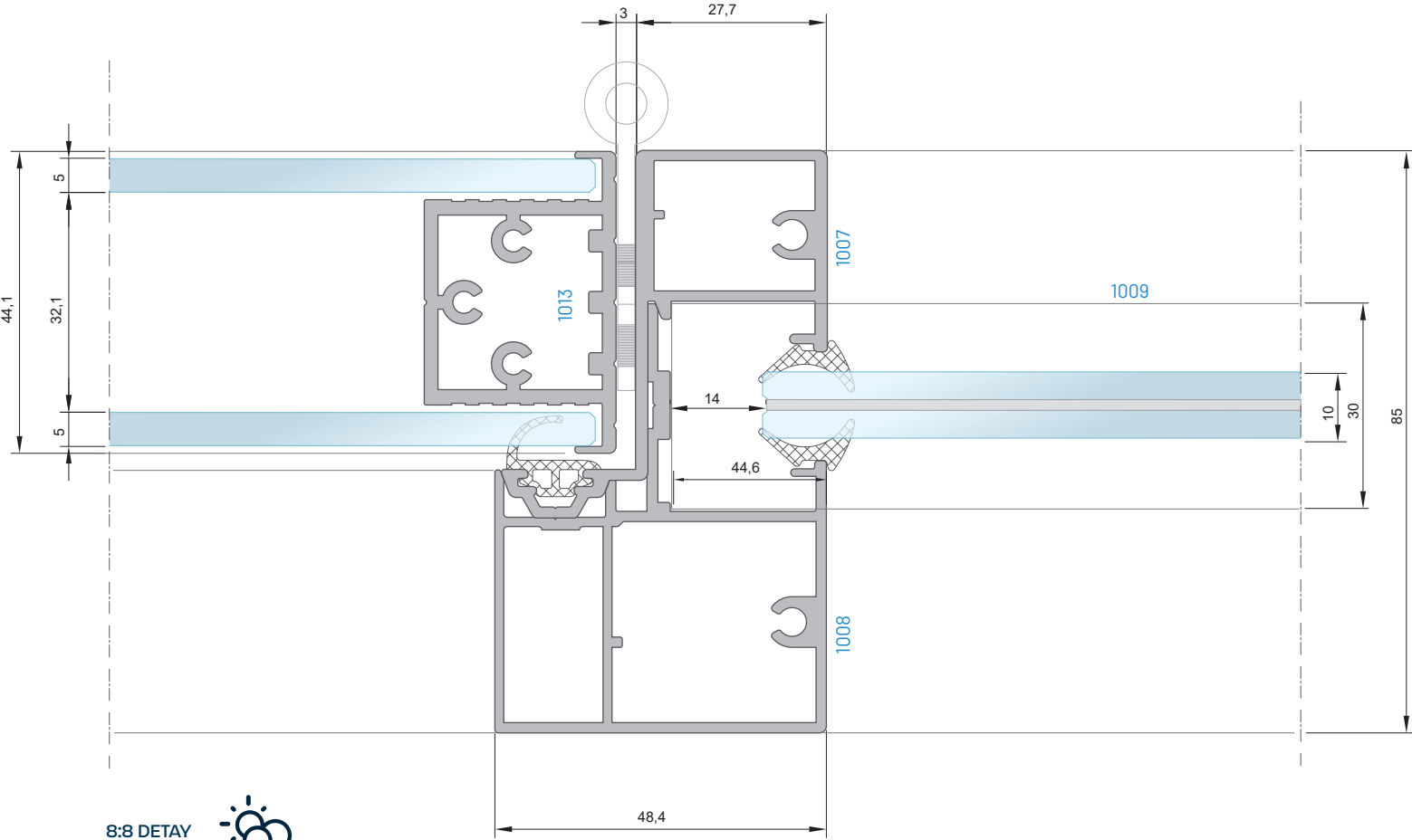
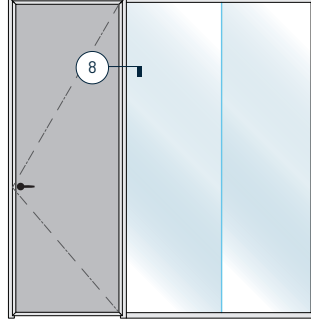

8:8 DETAY
8:8DETAIL  DIS / OUTSIDE

ÖLÇEK: 1:2
SCALE: 1:2

Dış Görünüş / Exterior View

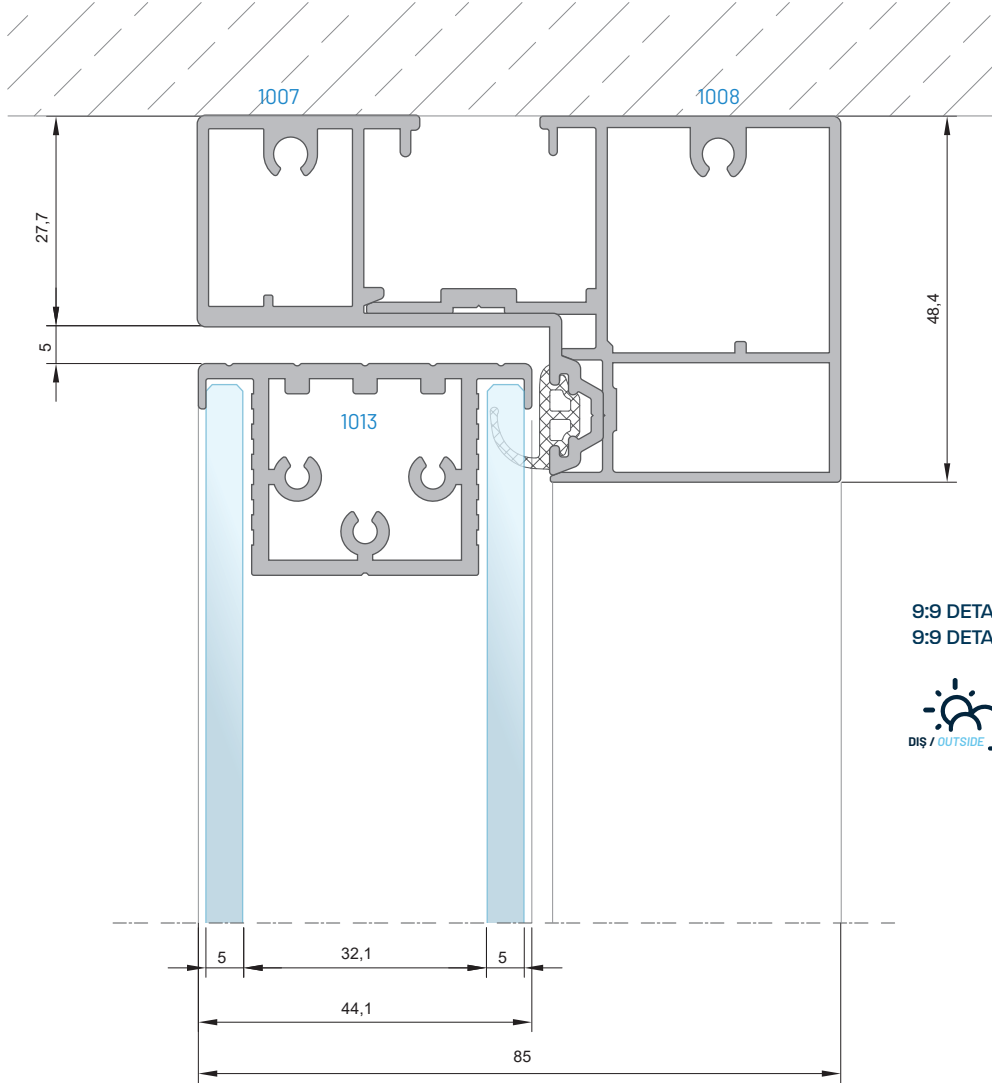
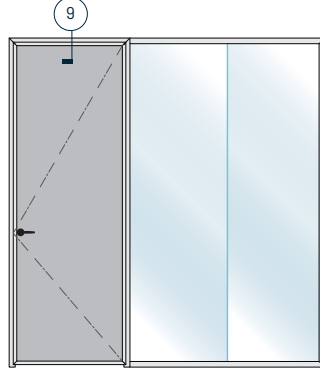

ÖLÇEK: 1:2
SCALE: 1:2

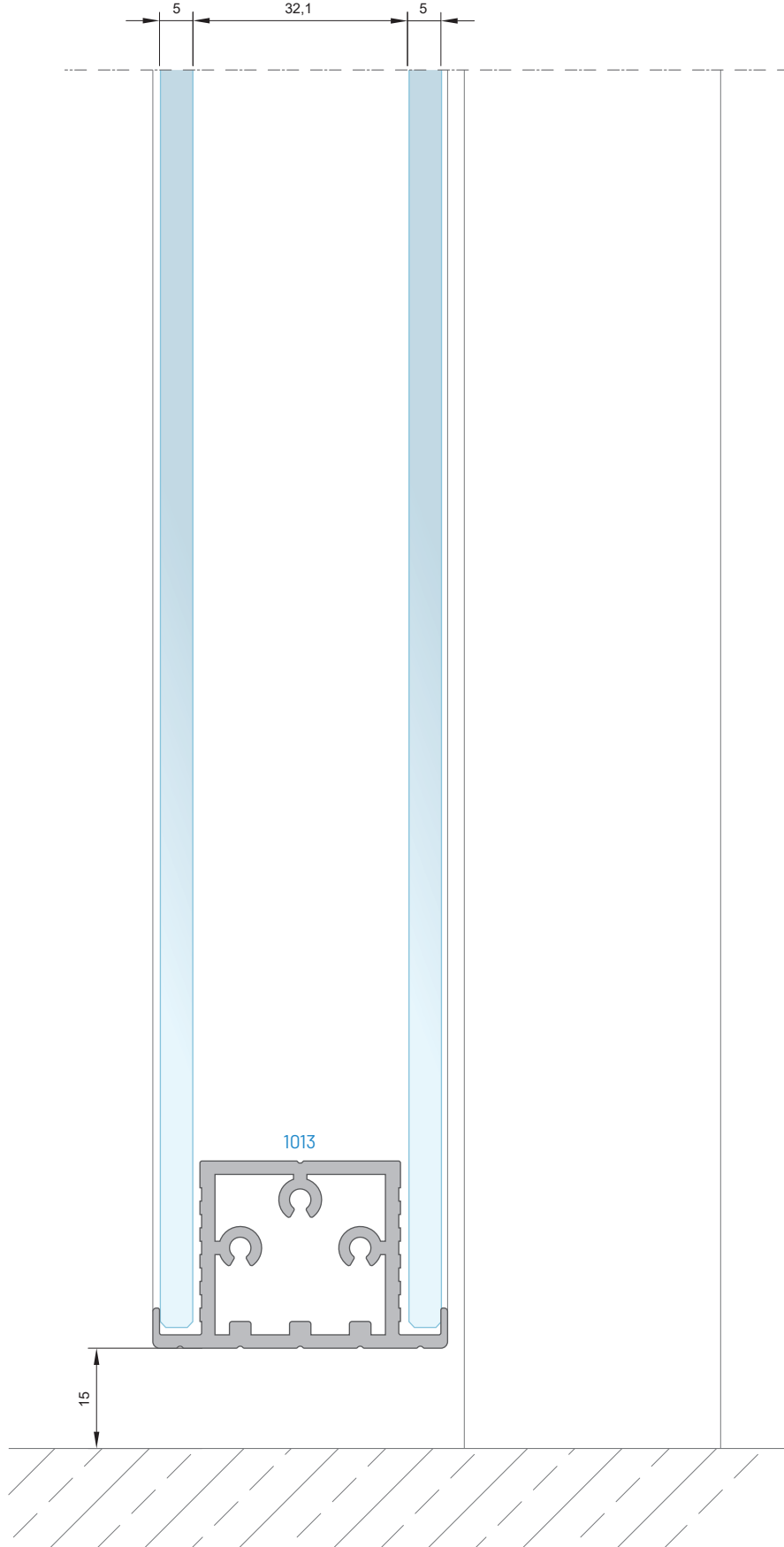
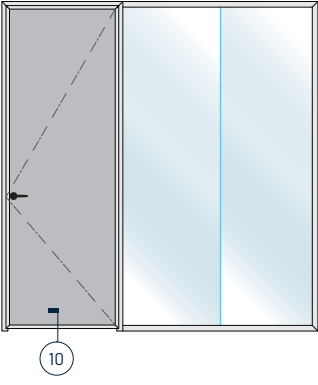

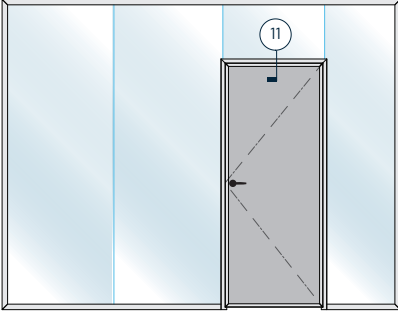

Dış Görünüş / Exterior View

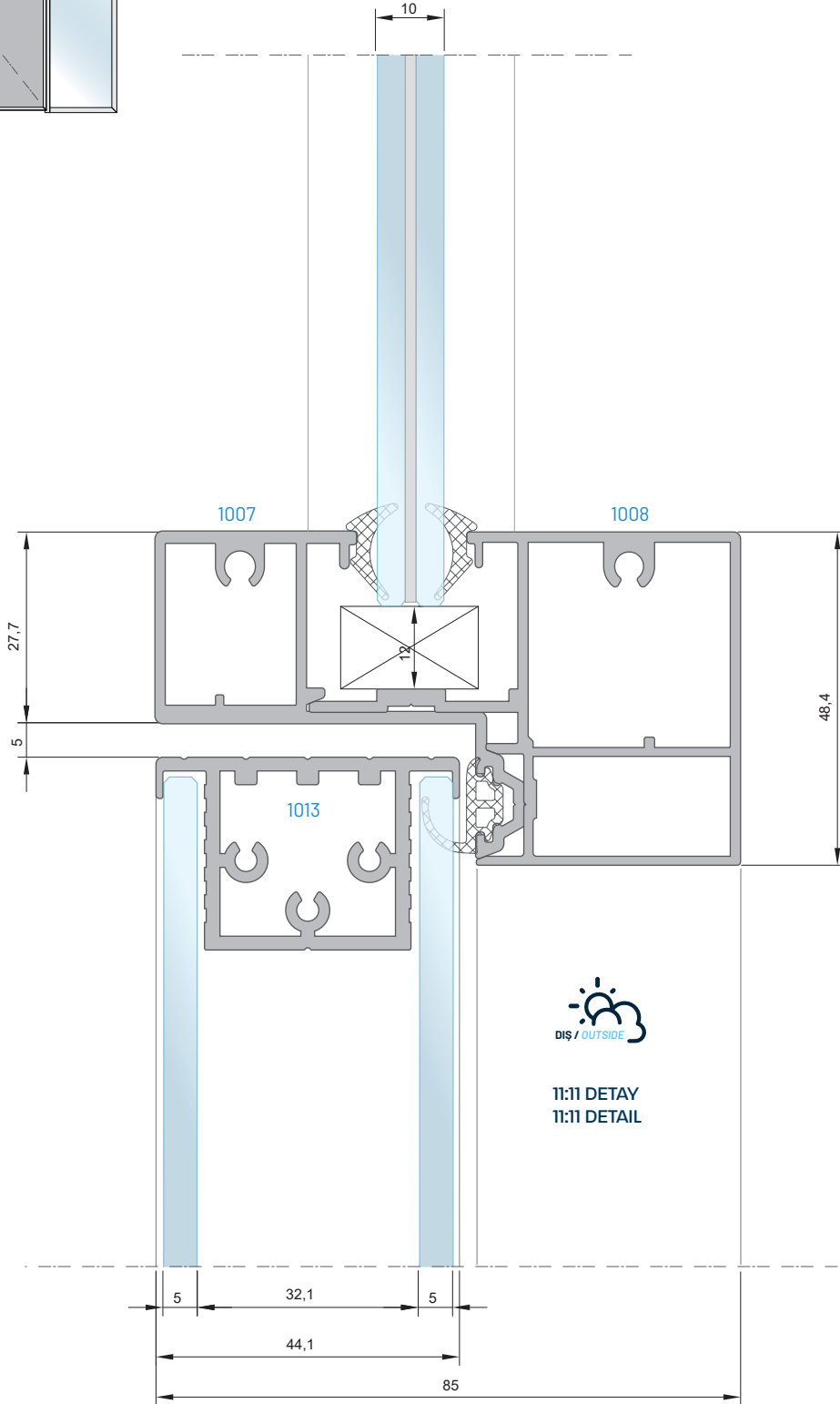

ÖLÇEK: 1:2
SCALE: 1:2

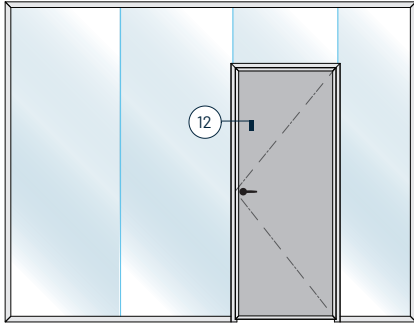

Dış Görünüş / Exterior View

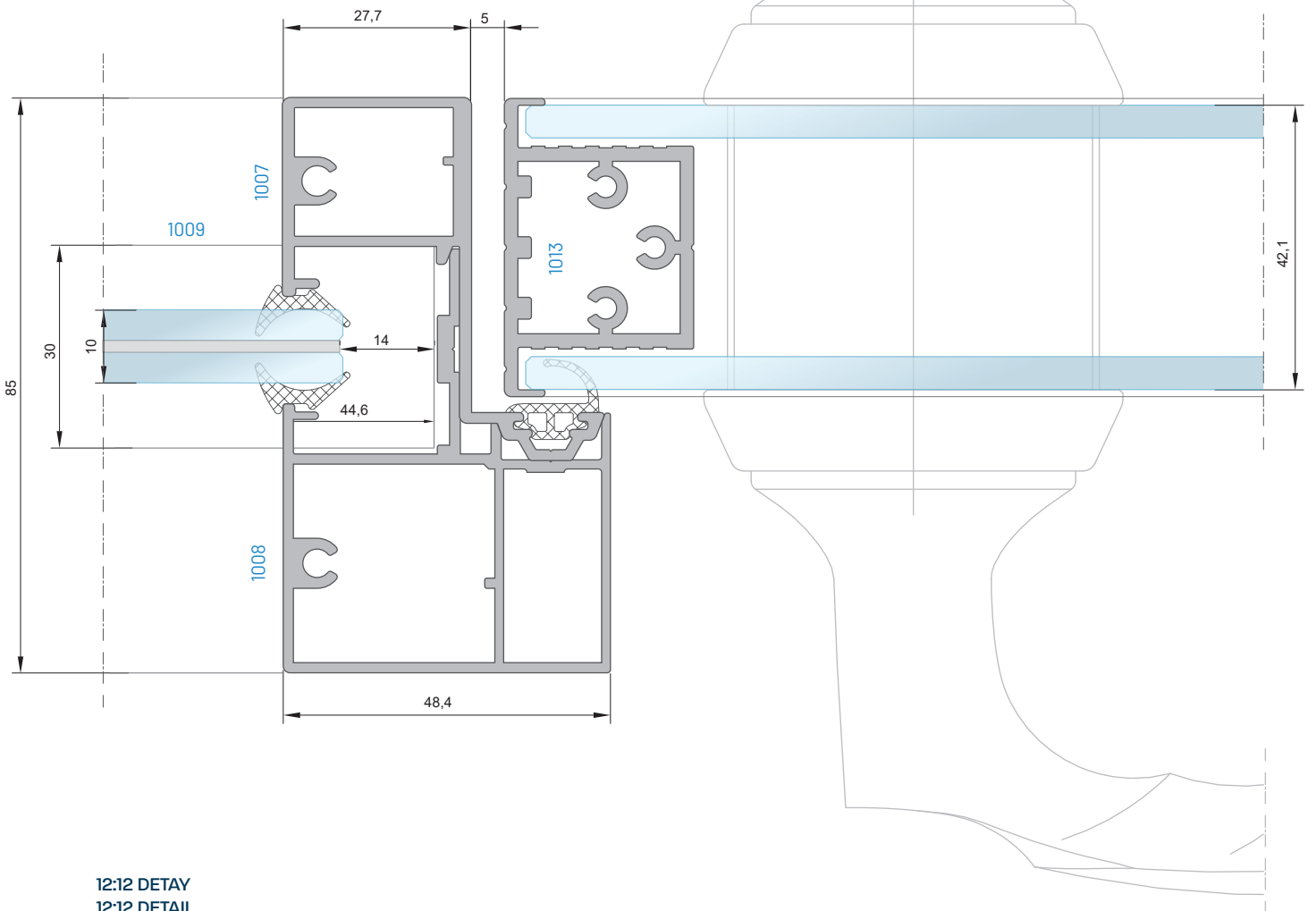
12:12 DETAY
12:12 DETAILÖLÇEK: 1:2
SCALE: 1:2

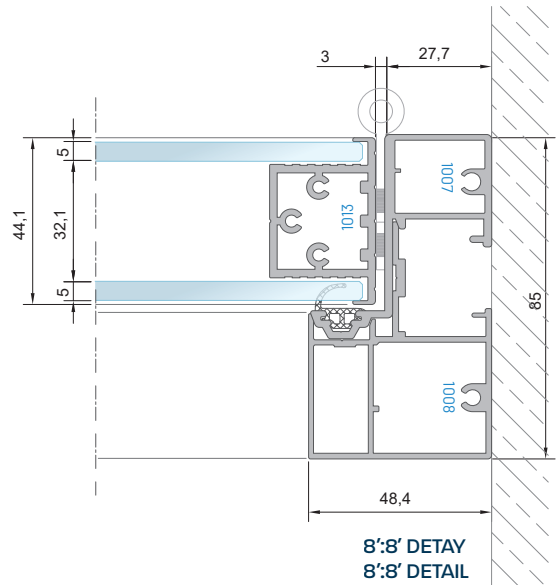
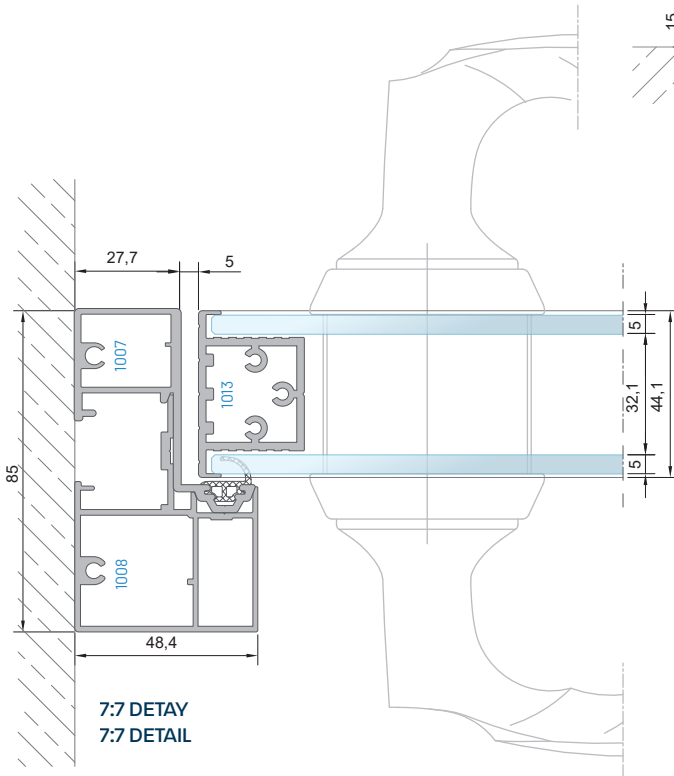
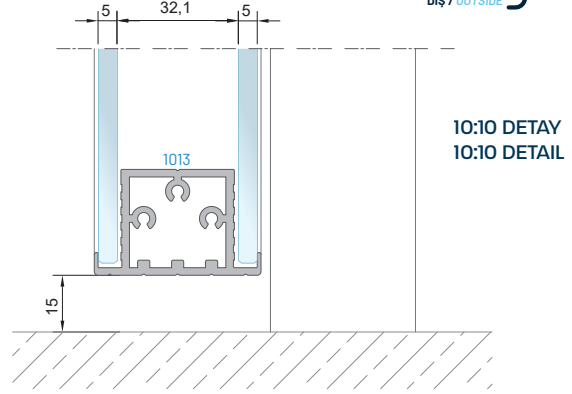
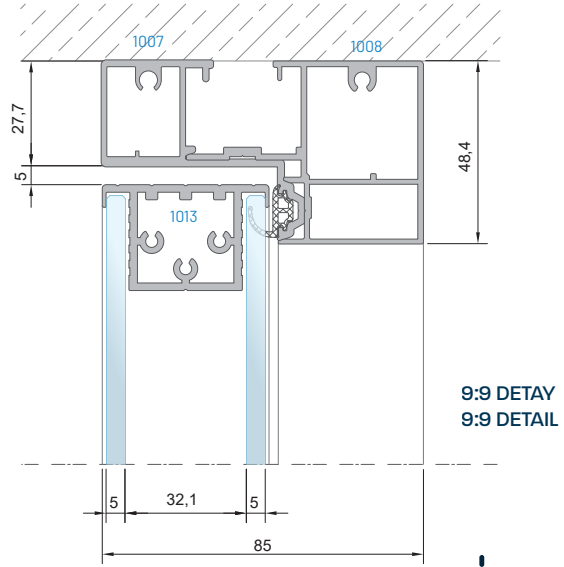
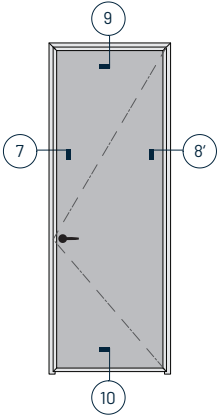

ÖLÇEK: 1:2
SCALE: 1:2

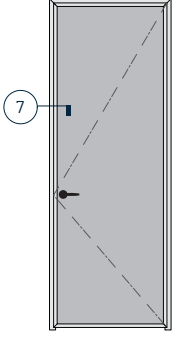

7:7 DETAY OPSİYONLARI
7:7 DETAILS OPTIONS

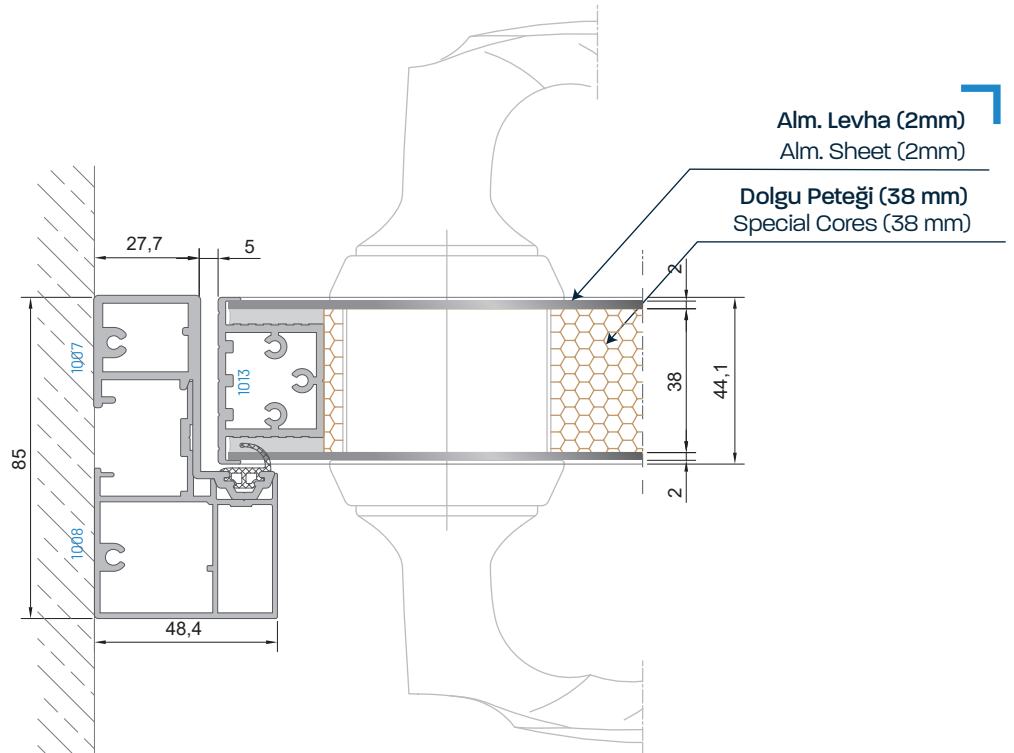
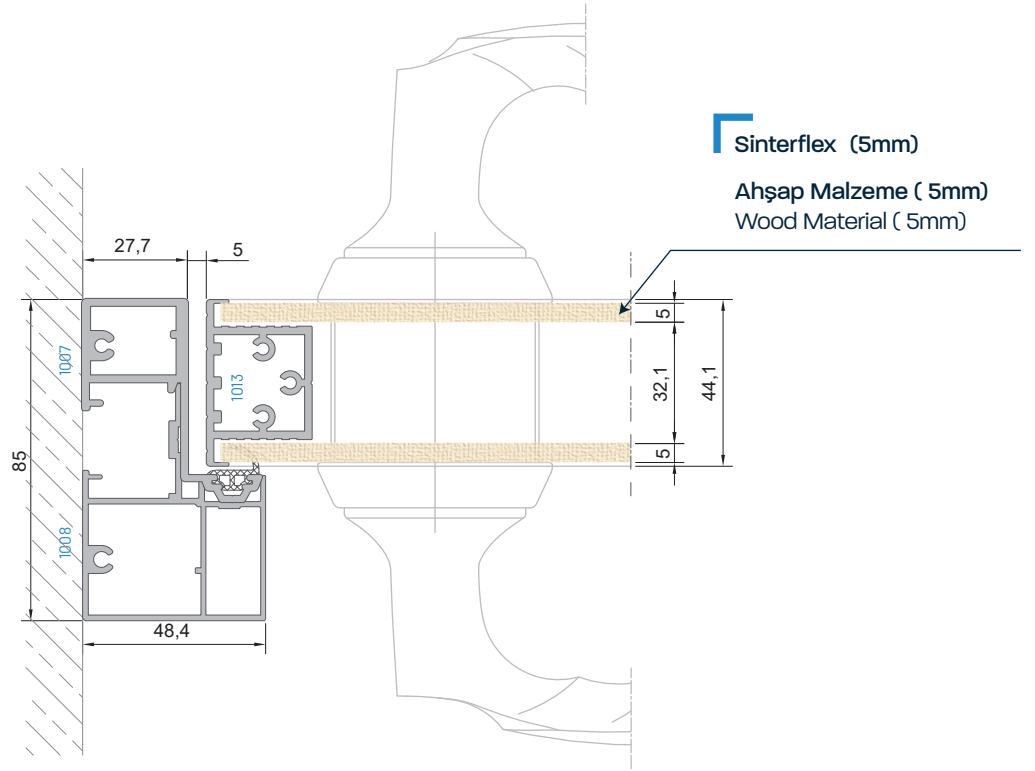

ÖLÇEK: 1:2
SCALE: 1:2

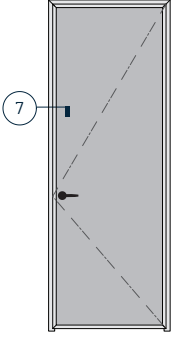

7:7 DETAY OPSİYONLARI
7:7 DETAILS OPTIONS

Bölgesel Emaye Boya (30 mm)
Local Enamel Paint (30 mm)

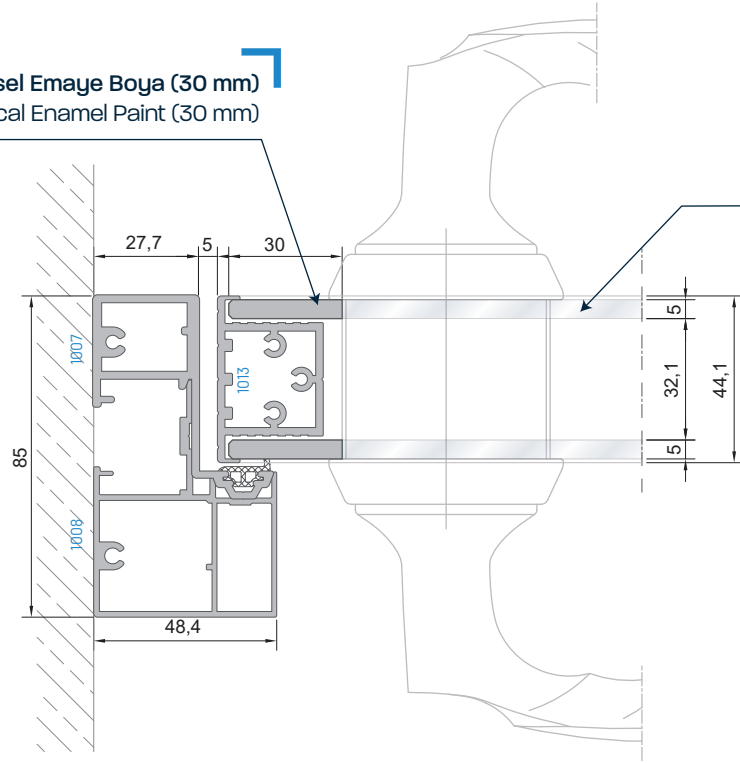

Şeffaf Cam
Clear Glass

Full Emaye Boyalı Cam
Full Enamel Paint Glass

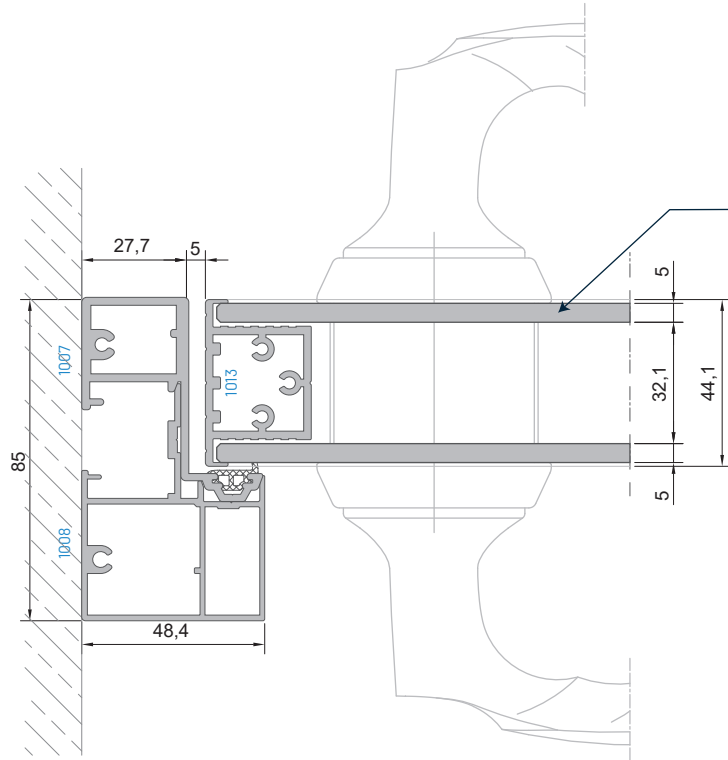

ÖLÇEK: 1:2
SCALE: 1:2

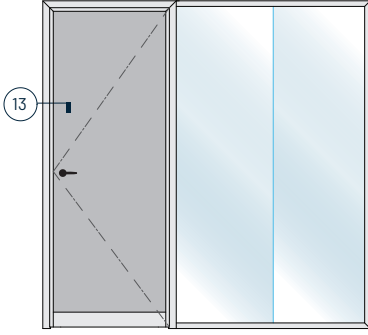

Dış Görünüş / Exterior View

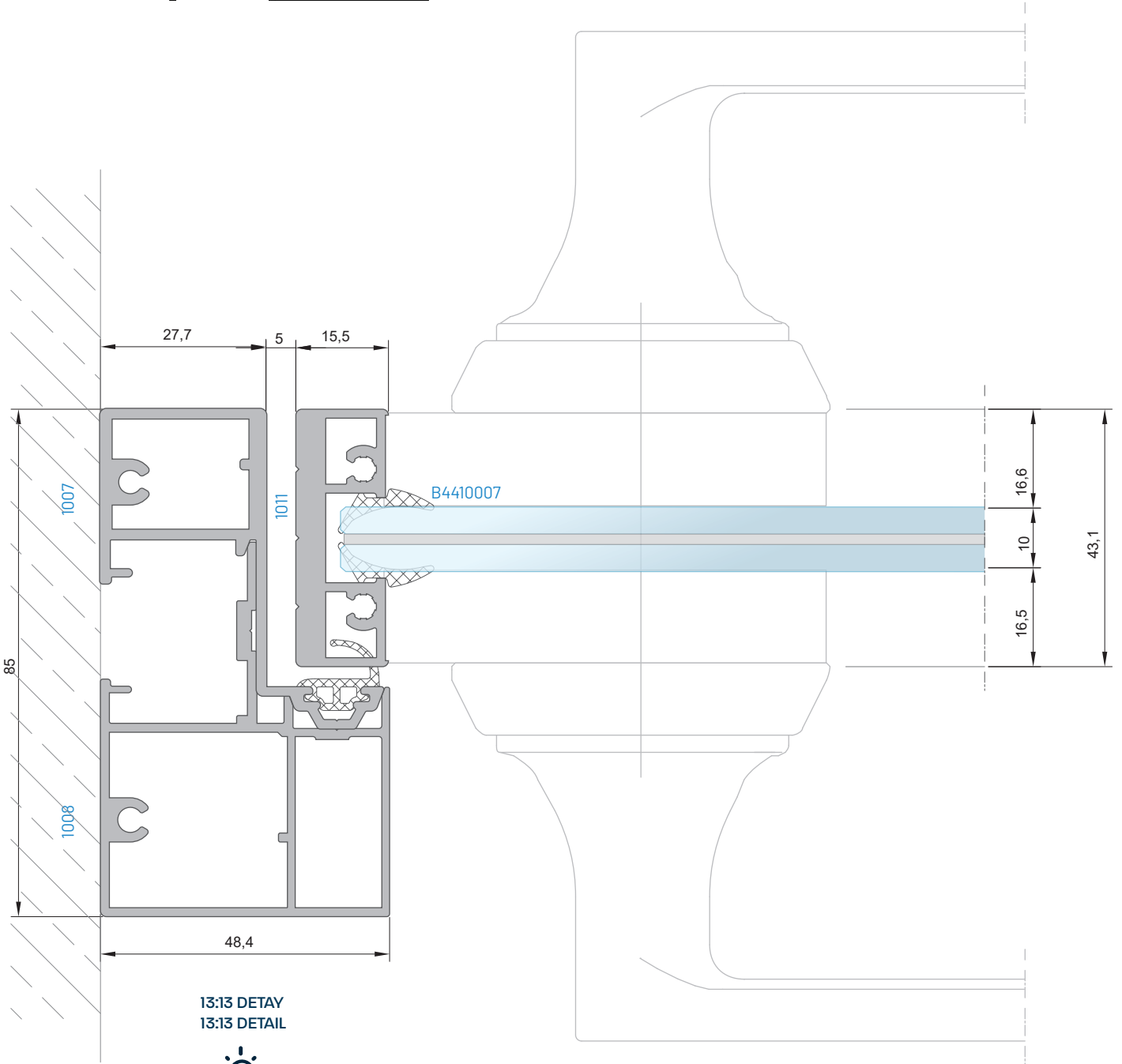

13:13 DETAY
13:13 DETAIL



ÖLÇEK: 1:2
SCALE: 1:2

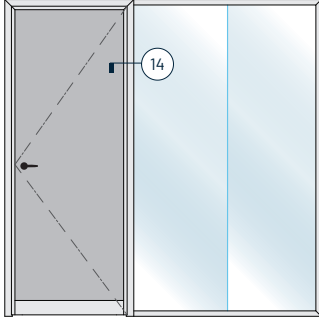

Dış Görünüş / Exterior View

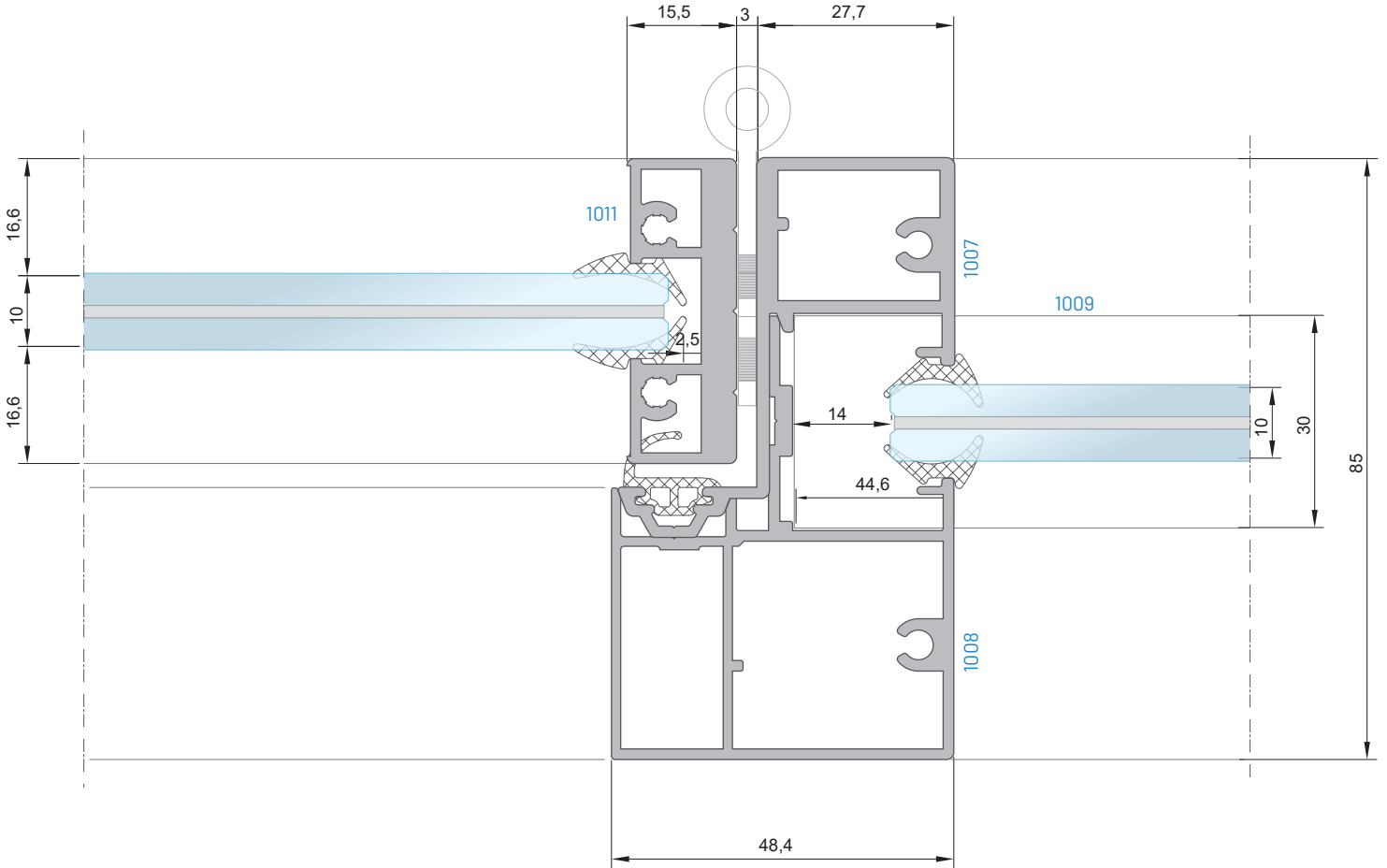
14:14 DETAY
14:14 DETAILÖLÇEK: 1:2
SCALE: 1:2

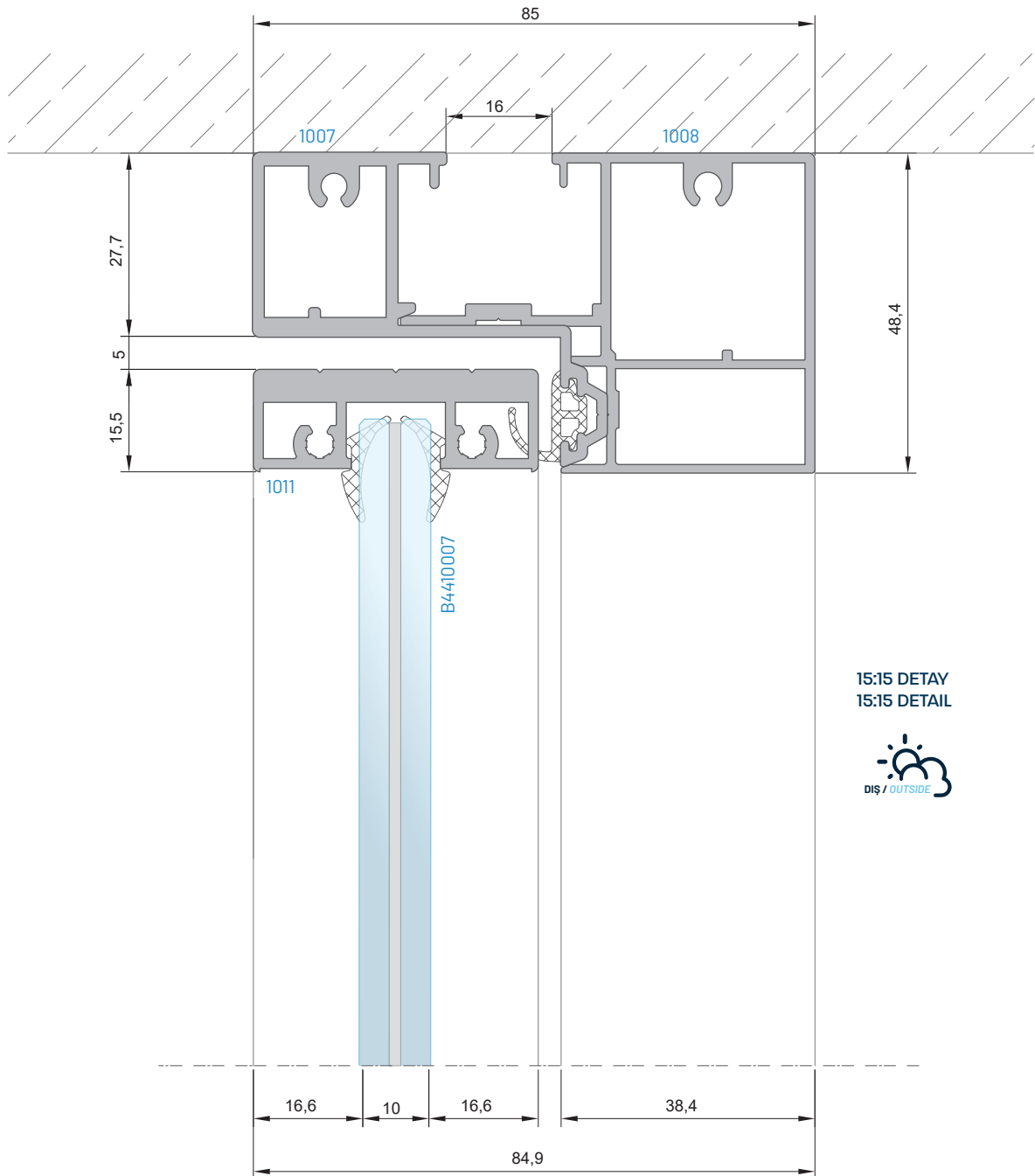
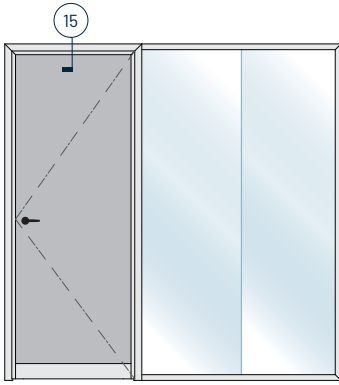

15:15 DETAY
15:15 DETAIL



ÖLÇEK: 1:2
SCALE: 1:2

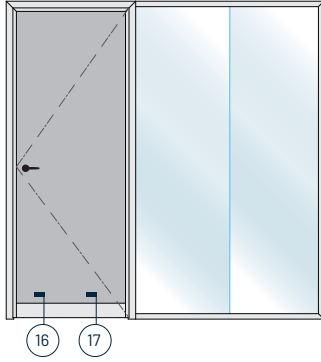

Alt Baza Alternatifleri
Bottom Sill Alternatives

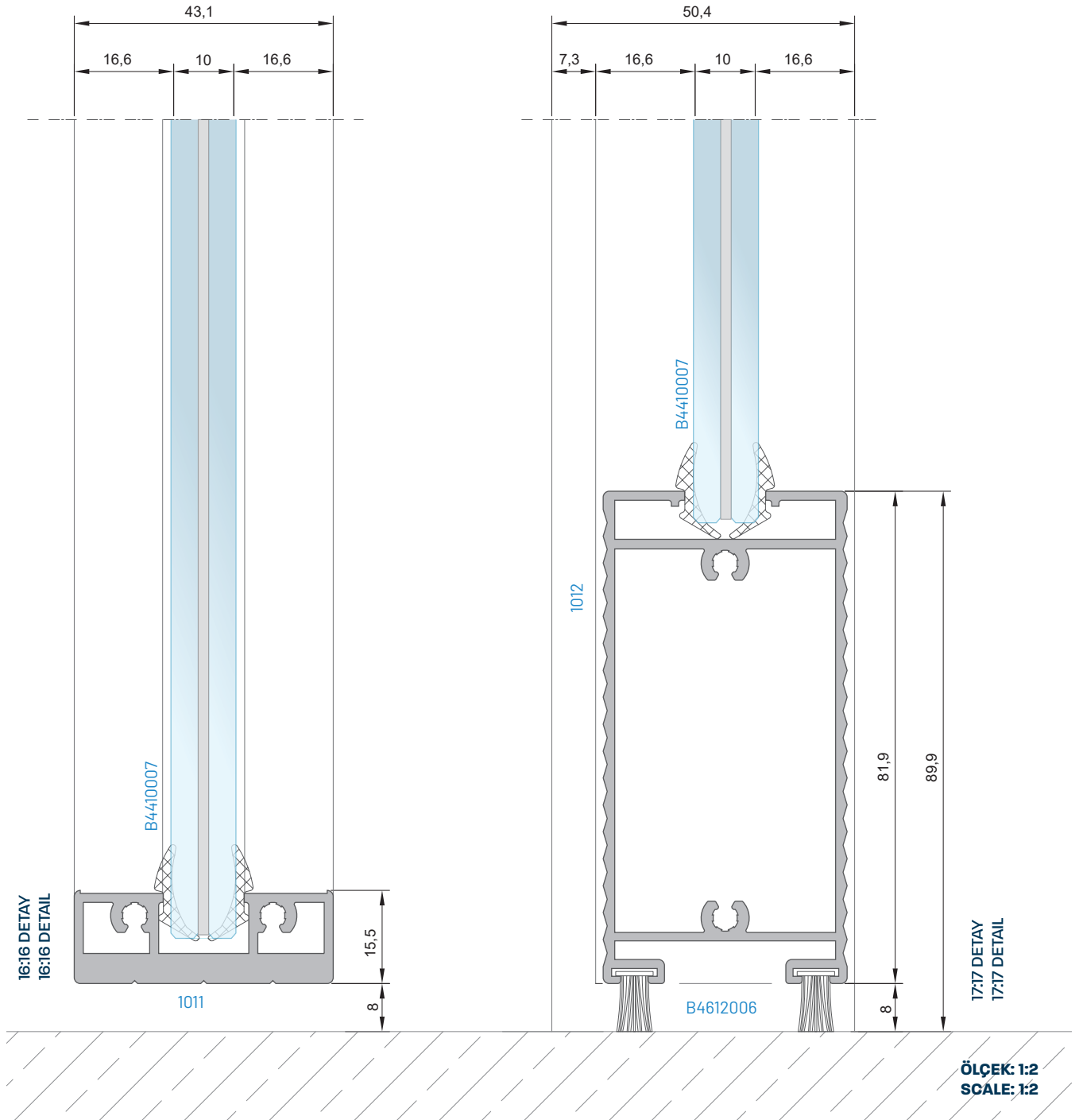

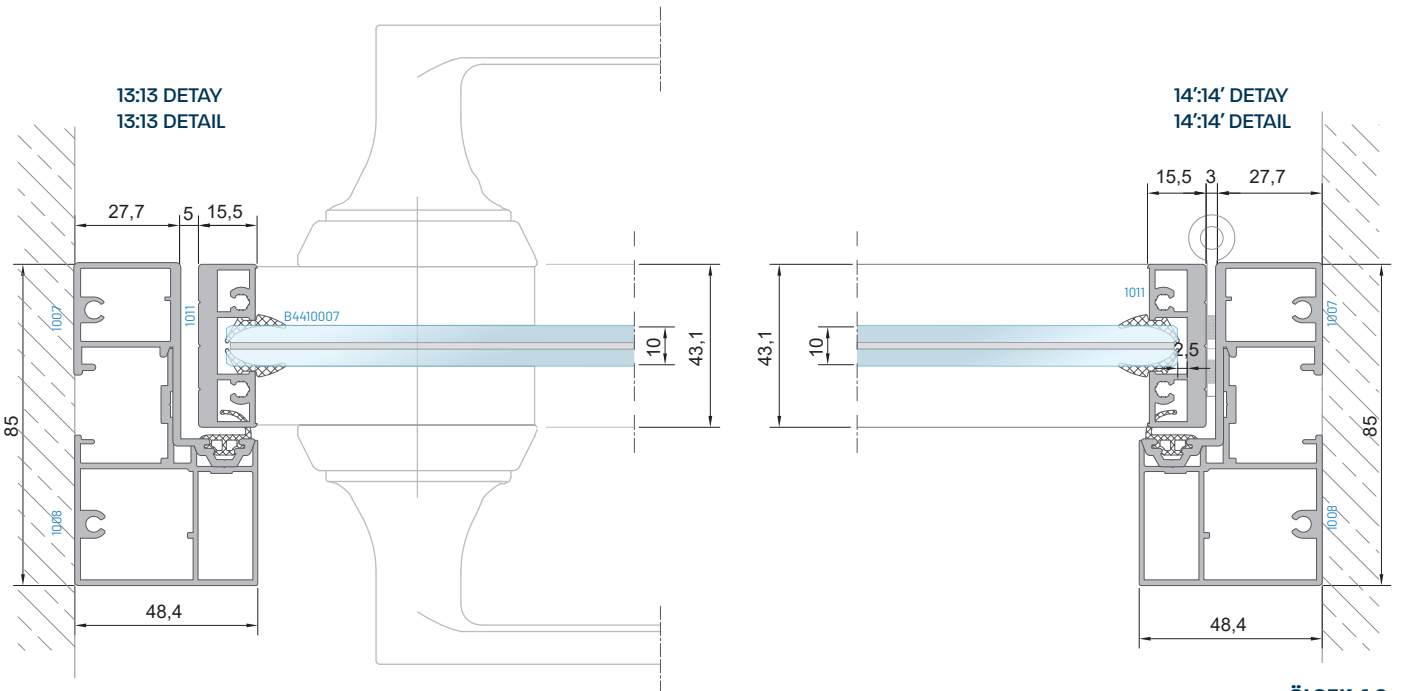
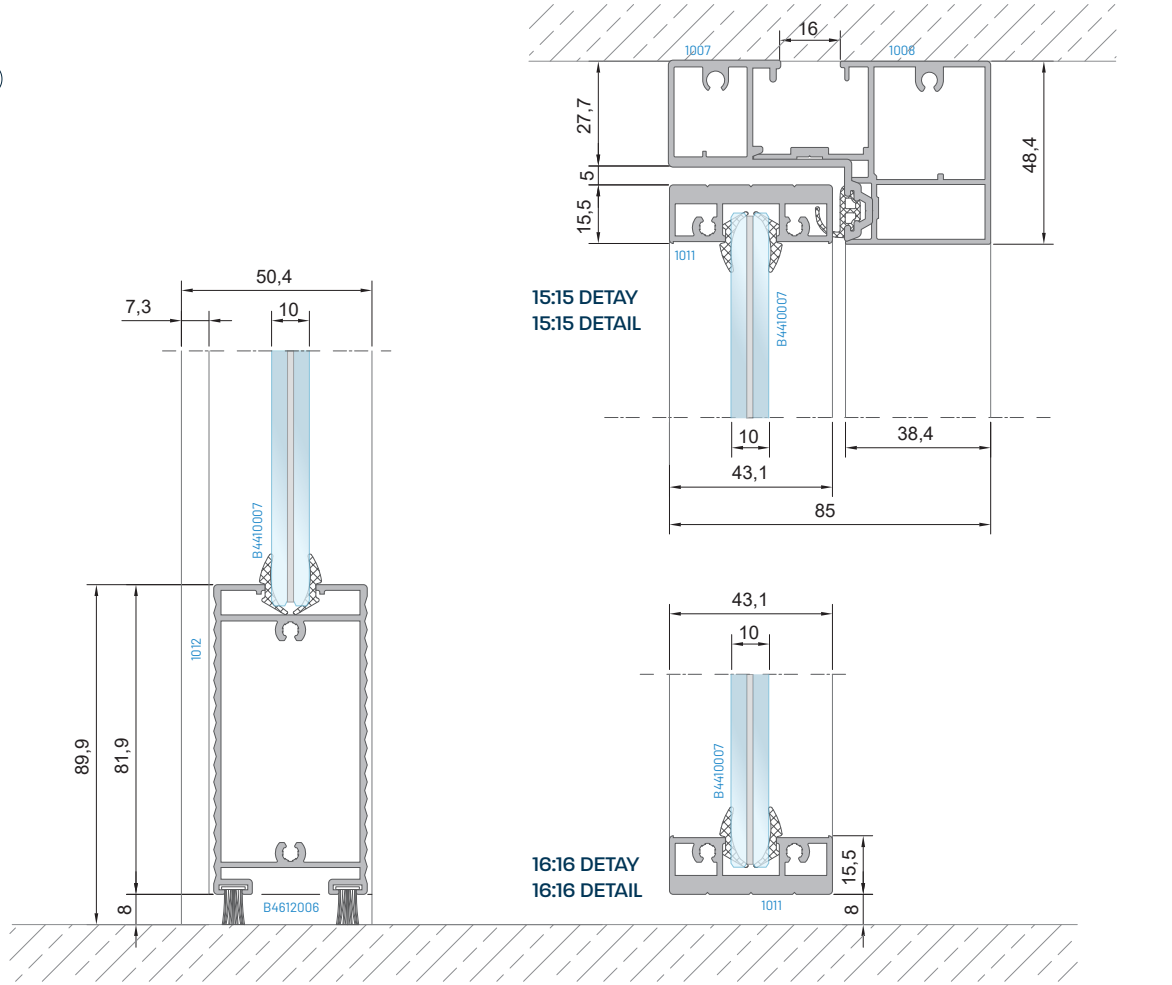
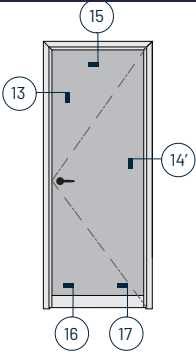

ÖLÇEK: 1:2
SCALE: 1:2



 **ALFORE**[®]

OFİS BÖLME
SİSTEMİ

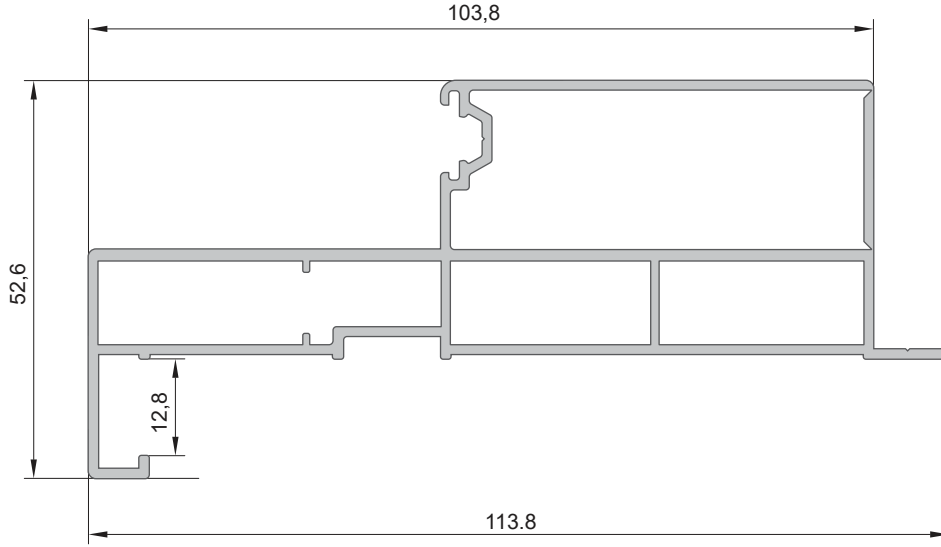
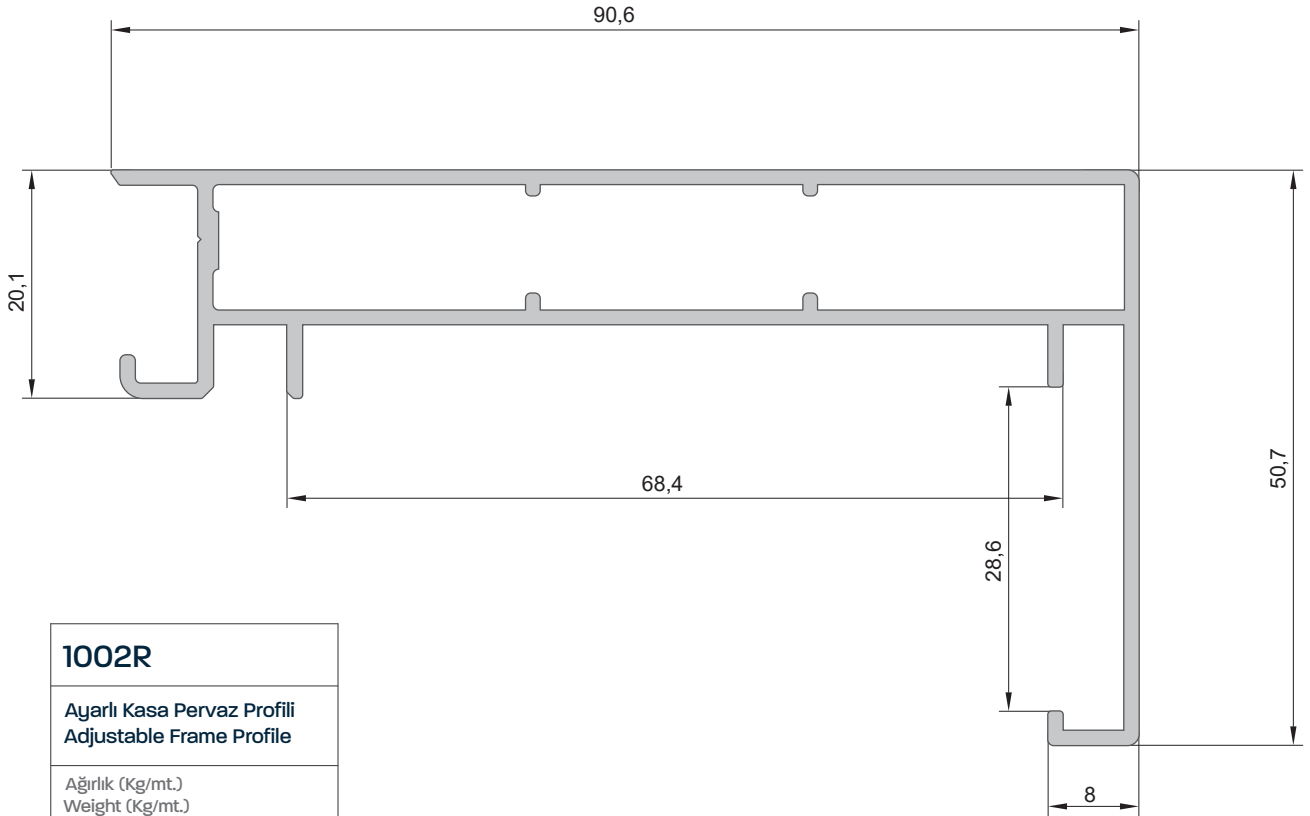

1100 SERİSİ

**1001R**Ayarlı Kasa Profili
Tuned Case ProfileAğırlık (Kg/mt.)
Weight (Kg/mt.)
1,489 Kg/mt.**1002R**Ayarlı Kasa Pervaz Profili
Adjustable Frame ProfileAğırlık (Kg/mt.)
Weight (Kg/mt.)
0,940 Kg/mt.

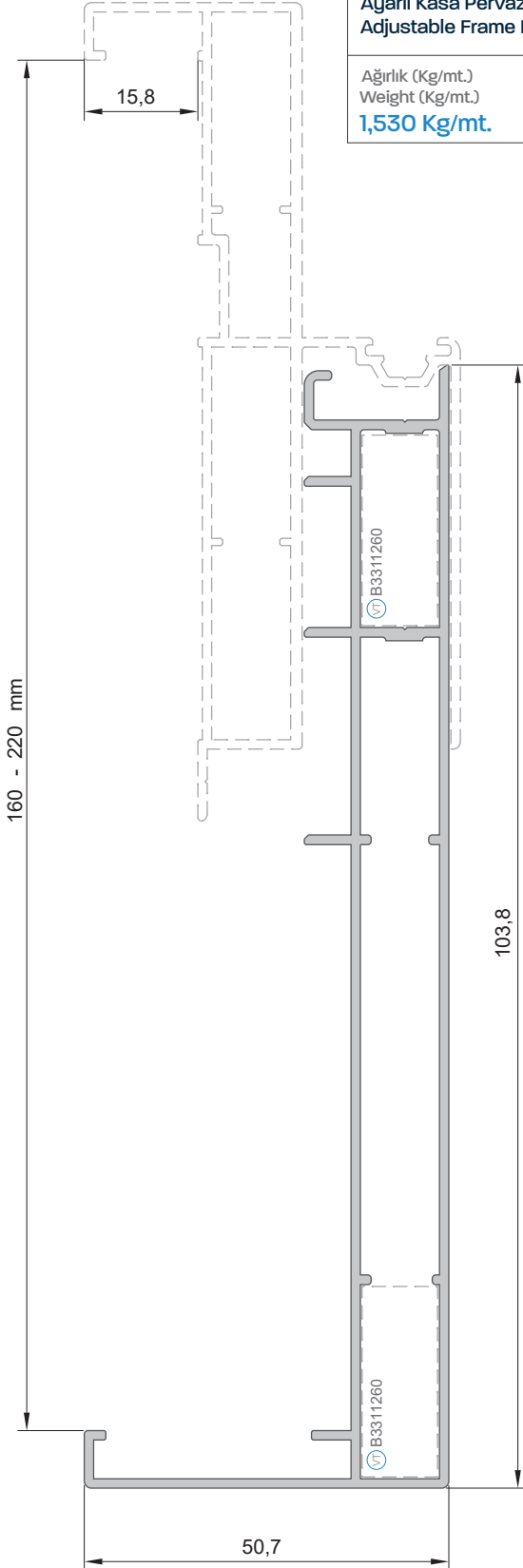
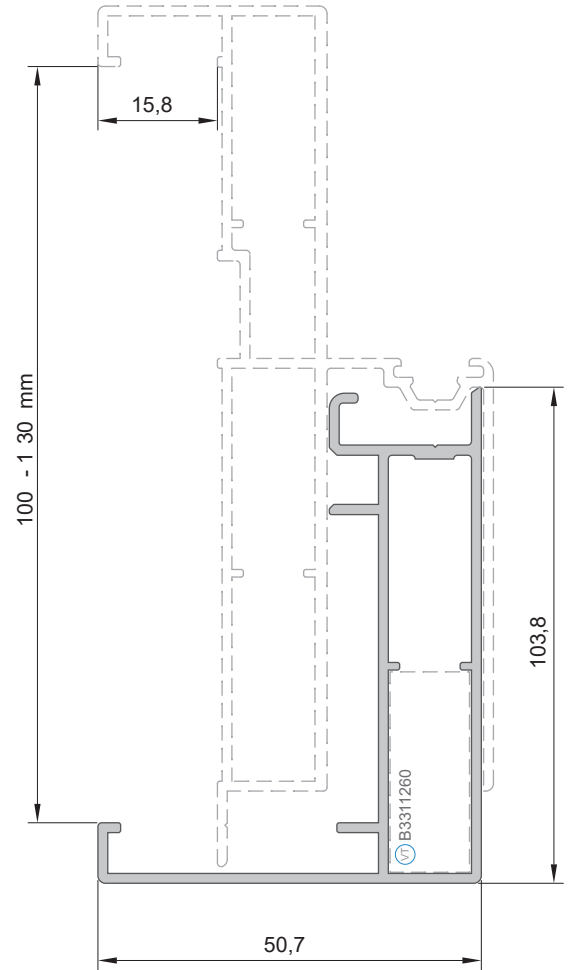
1004Ayarlı Kasa Pervaz Profili
Adjustable Frame ProfileAğırlık (Kg/mt.)
Weight (Kg/mt.)
1,530 Kg/mt.**1005**Ayarlı Kasa Pervaz Profili
Adjustable Frame ProfileAğırlık (Kg/mt.)
Weight (Kg/mt.)
0,785 Kg/mt.

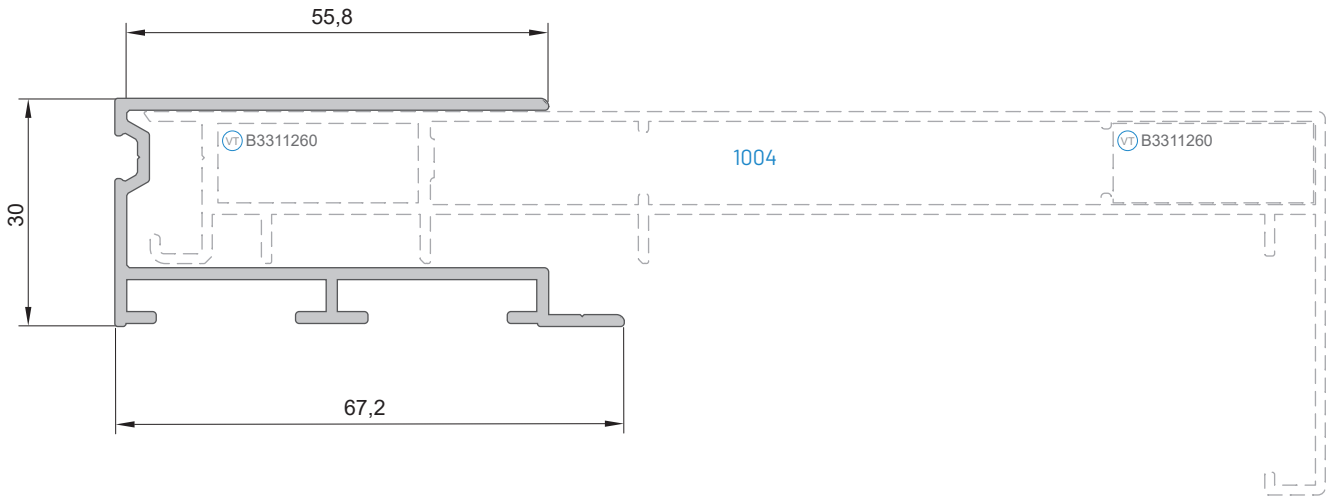
**1058****Cam Kapı Kasa Adaptör Prof.
Glass Door Adjustable Fr. Pr.**

Ağırlık (Kg/mt.)
Weight (Kg/mt.)
0,696 Kg/mt.

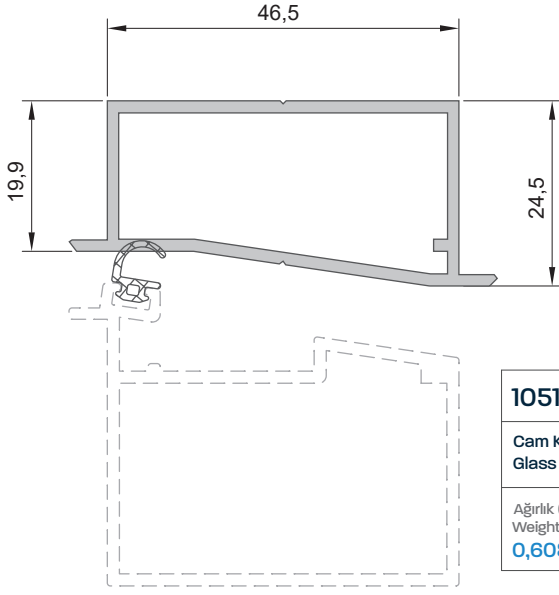

1051
Cam Kapı Kanat Profili Glass Door Sash Profile
Ağırlık (Kg/mt.) Weight (Kg/mt.) 0,608 Kg/mt.

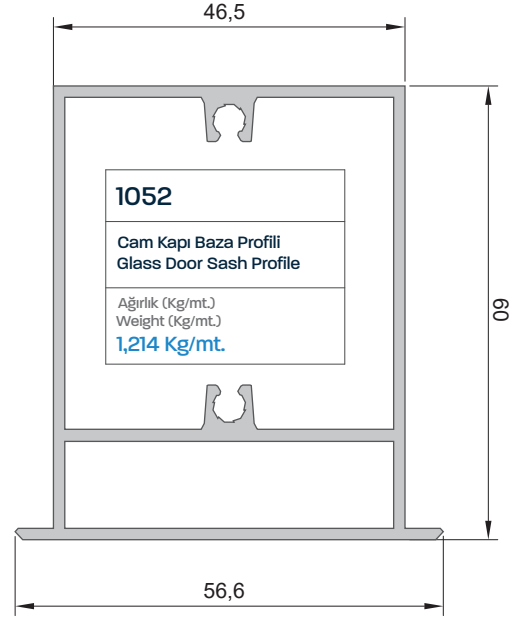

1052
Cam Kapı Baza Profili Glass Door Sash Profile
Ağırlık (Kg/mt.) Weight (Kg/mt.) 1,214 Kg/mt.

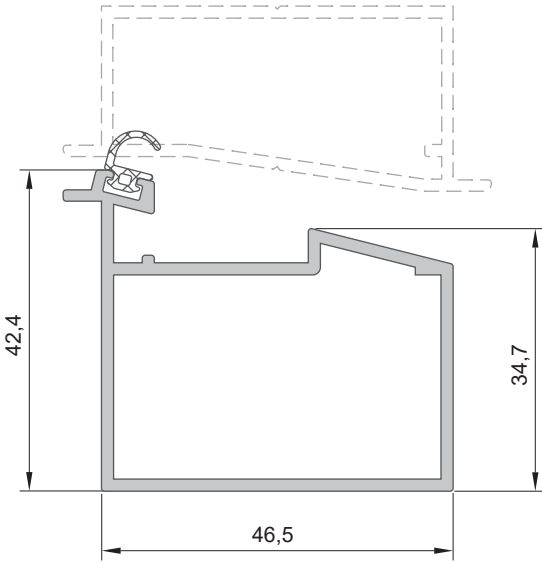

1050
Cam Kapı Kasa Profili Glass Door Case Profile
Ağırlık (Kg/mt.) Weight (Kg/mt.) 0,781 Kg/mt.

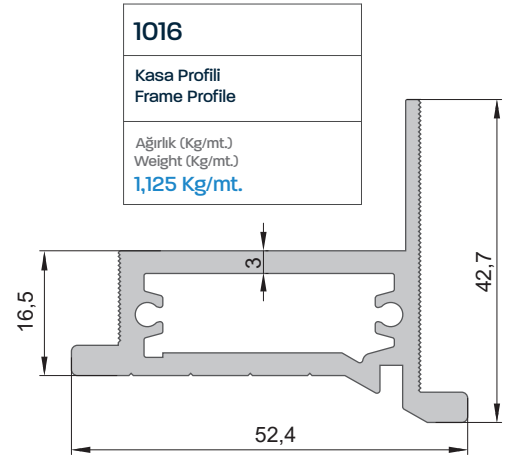

1016
Kasa Profili Frame Profile
Ağırlık (Kg/mt.) Weight (Kg/mt.) 1,125 Kg/mt.

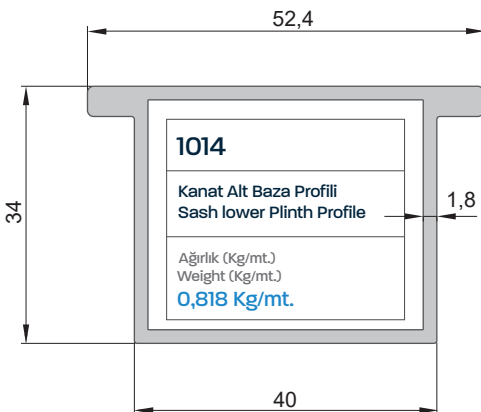





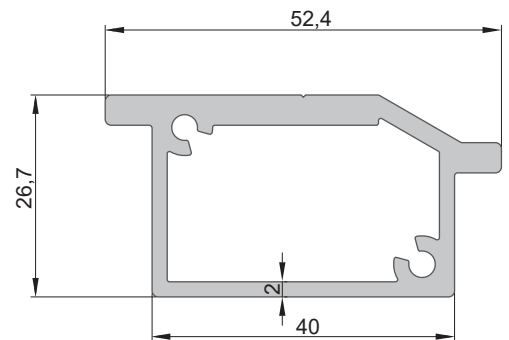

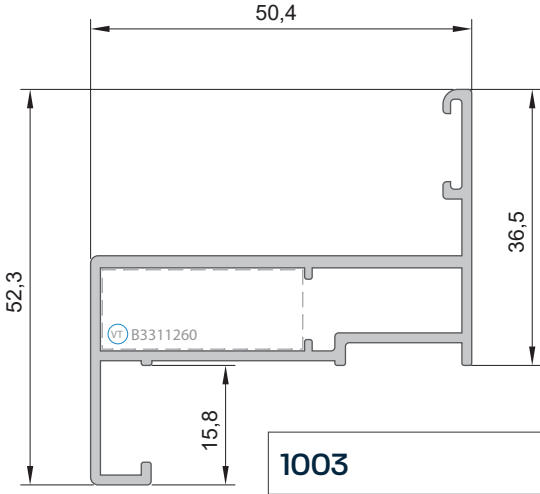
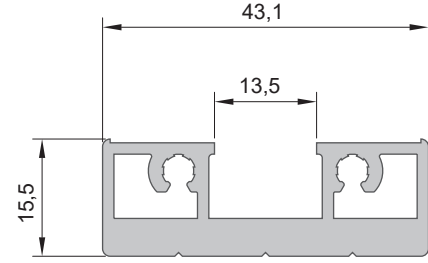
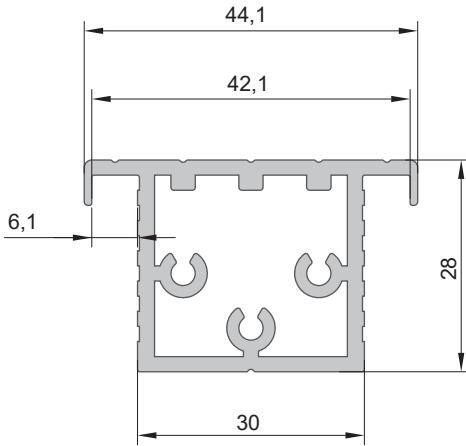
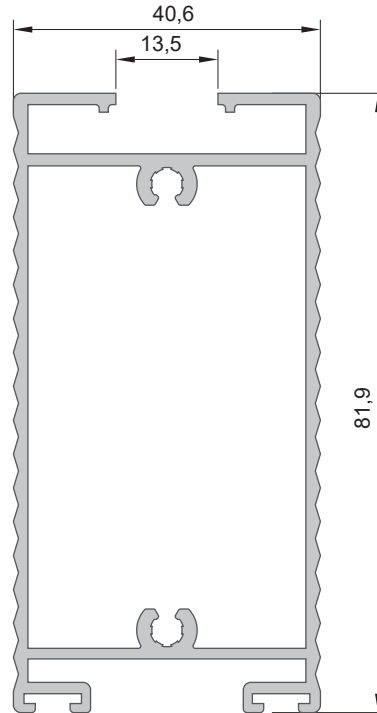

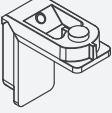



1014
Kanat Alt Baza Profili Sash lower Plinth Profile
Ağırlık (Kg/mt.) Weight (Kg/mt.) 0,818 Kg/mt.

1015
Kanat Profili Sash Profile
Ağırlık (Kg/mt.) Weight (Kg/mt.) 1,019 Kg/mt.



**1003****Kasa Profili**
Single Casing ProfileAğırlık (Kg/mt.)
Weight (Kg/mt.)
0,684 Kg/mt.**1011****Kanat Profili**
Sash ProfileAğırlık (Kg/mt.)
Weight (Kg/mt.)
0,921 Kg/mt.**1013****Cam Kapı Kanat**
Glass Sash ProfileAğırlık (Kg/mt.)
Weight (Kg/mt.)
0,920 Kg/mt.**1012****Cam Kapı Baza**
Glass Sill ProfileAğırlık (Kg/mt.)
Weight (Kg/mt.)
1,326 Kg/mt.

Aksesuarlar Accessories	Aksesuar Kodu Nr of Accessories	Malzeme Türü Material	Açıklama Description	Kullanıldığı Profil -----
	B3311260 VT	Döküm Cast	Vidalı Köşe Bağlantı Takozu Screwed Corner Cleat	LR-1001, LR-1002 LR-1003
	B7410119	Alüminyum Aluminium	Hoppe HCS Kol Hoppe HCS Handle	(Cam Duvar- Cam Kapı birleşiminde LR1051 Profilinde özel flanşlı kol sipariş geçilecektir.) LR-1011, LR-1013
	B6510136	Krom Chromium	Yaprak Menteşe Leaf Hinge	LR-1001, LR-1003 LR-1011, LR-1013
	B6510009	Krom Chromium	Alt-Üst Menteşe Top-Bottom Hinge	LR-1050, LR-1051 LR-1052
	B6160011	Krom Chromium	Alt-Üst Menteşe Kapağı Top-Bottom Hinge Cover	
	B4210026	EPDM EPDM	Kanat Contası Sash Gasket	152 mt. 
	B4310004	EPDM EPDM	Kanat Contası Sash Gasket	50 mt. 
	B4410007	EPDM EPDM	1,5-2 mm. Dış Cam Fitolü 1,5-2 mm. Insulating Gasket	255 mt. 
	B4612006	Polipropilen Polypropylene	67x1000 Fırça Fitolü 67x1000 Sealing Brush	800 mt. 

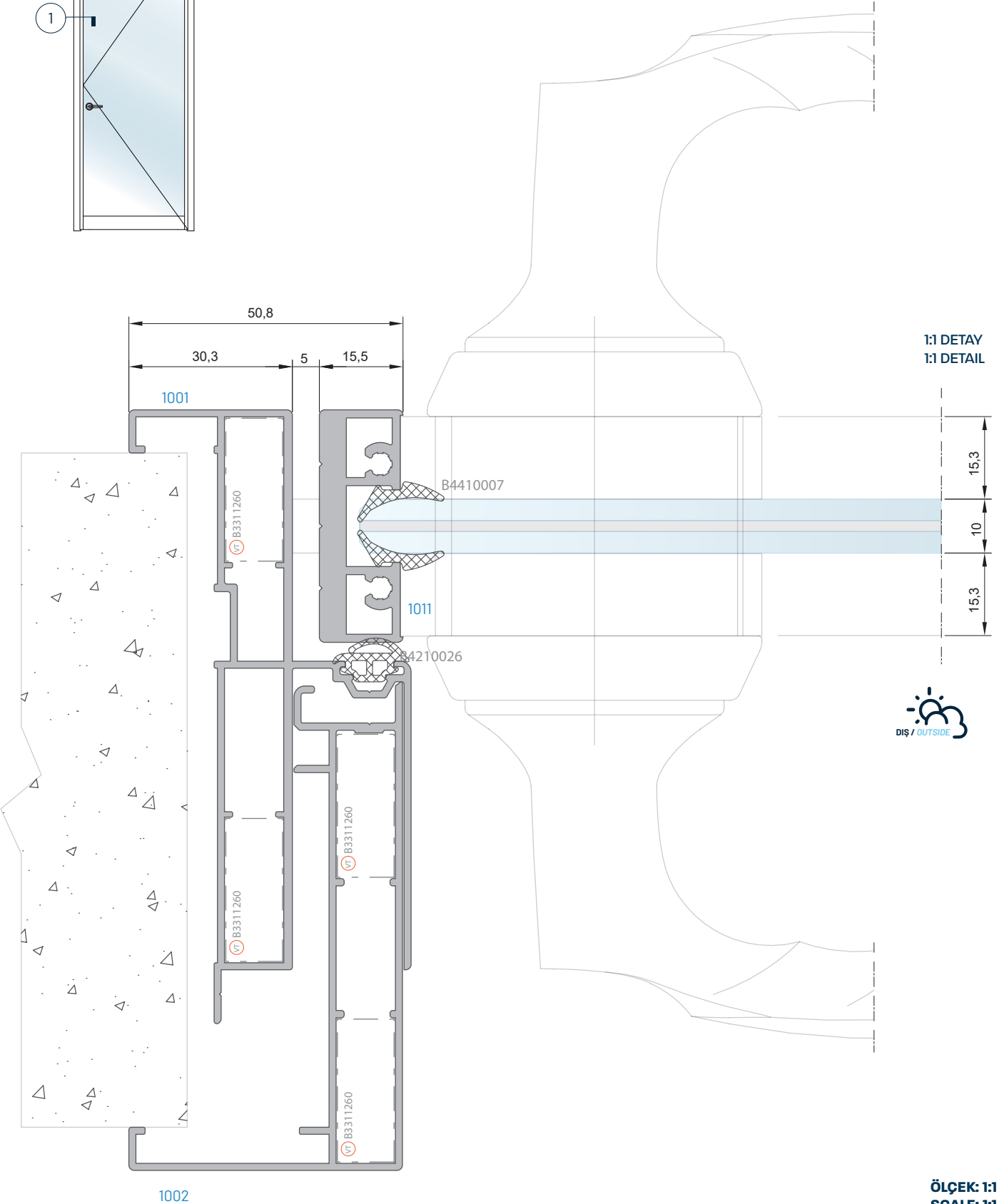
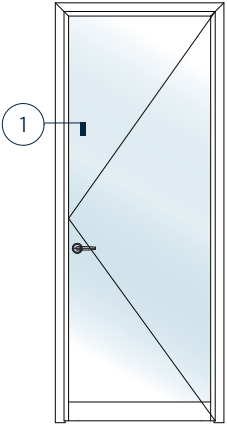

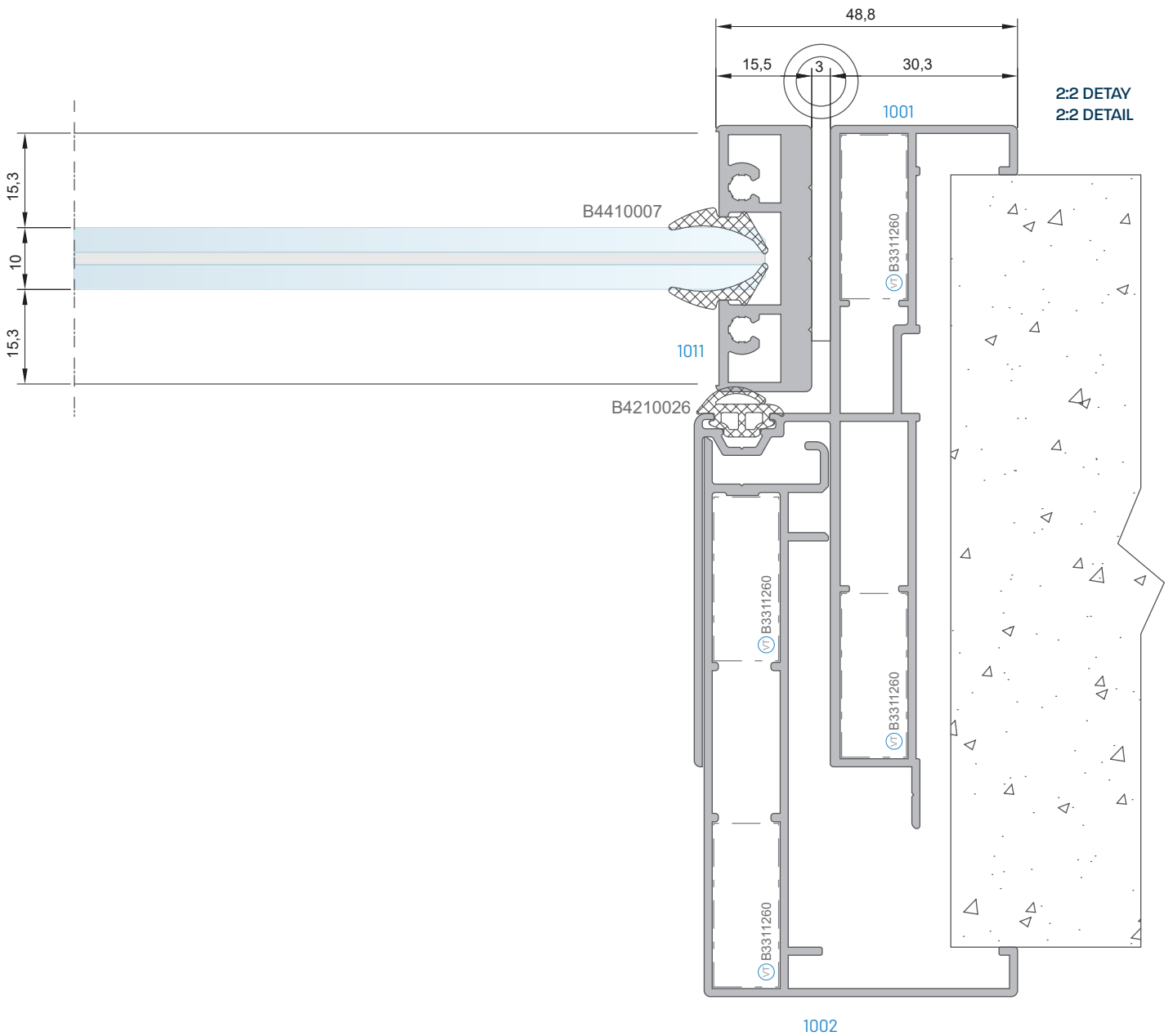
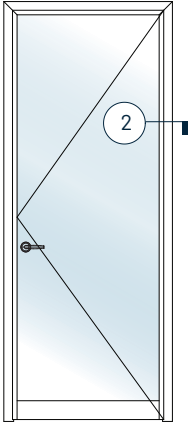

ÖLÇEK: 1:1
SCALE: 1:1

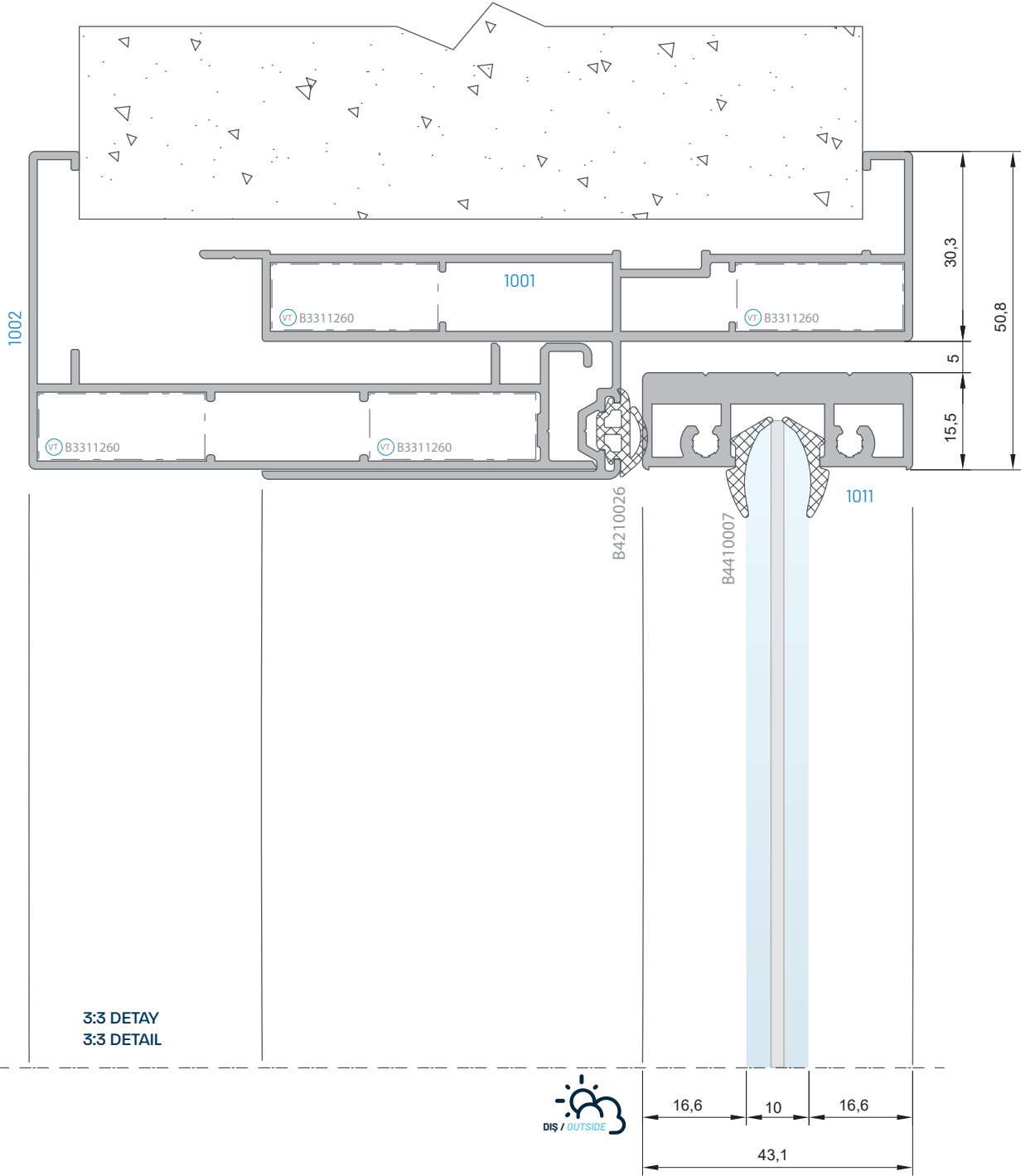
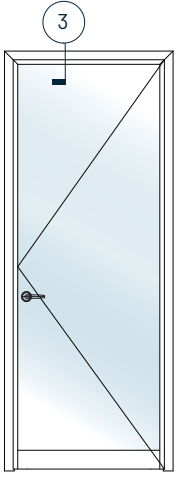

ÖLÇEK: 1:1
SCALE: 1:1

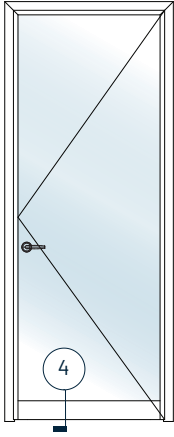

Alt Baza Alternatifleri

Sill Profile Alternatives

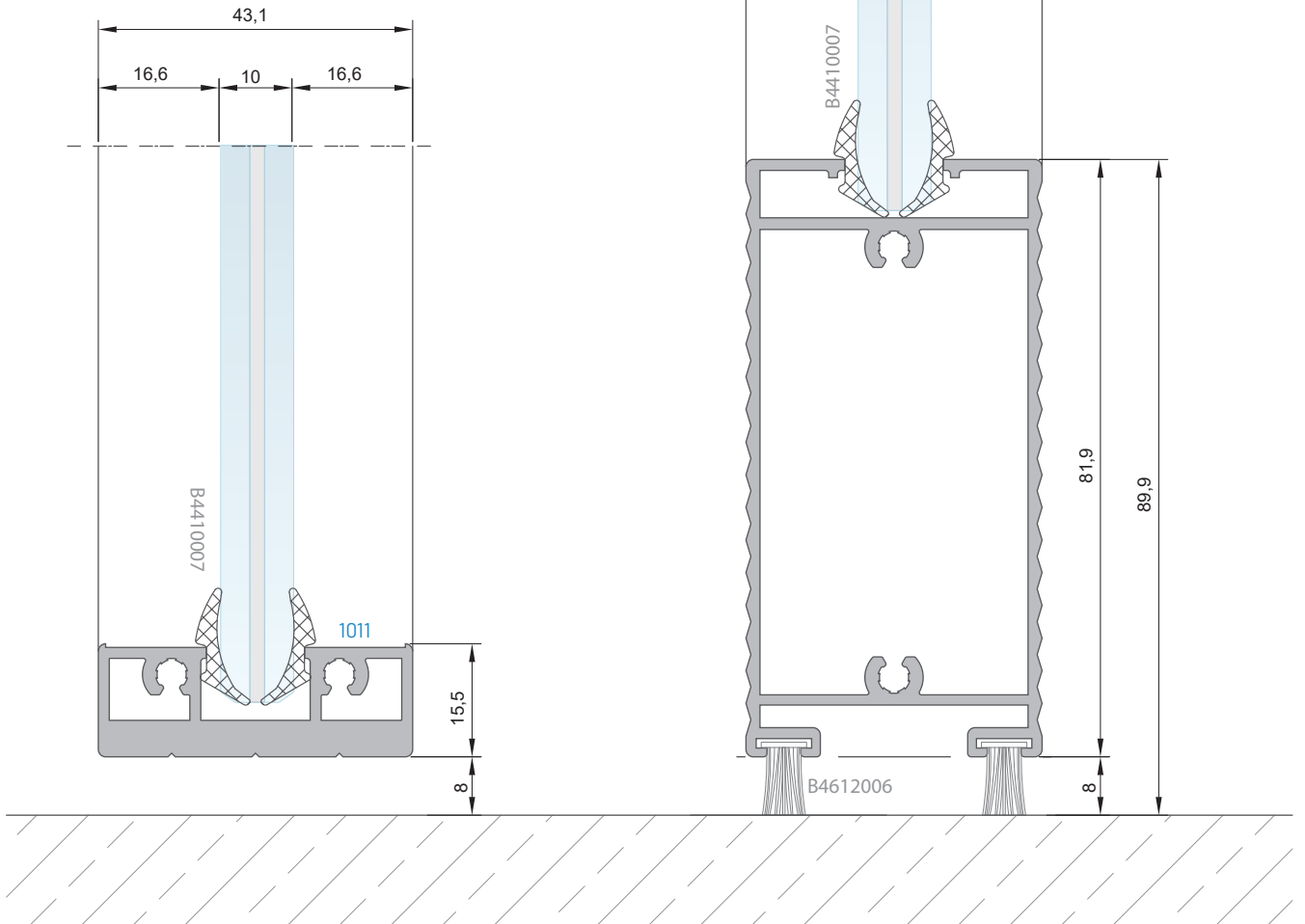

4:4 DETAY
4:4 DETAIL

ÖLÇEK: 1:1
SCALE: 1:1

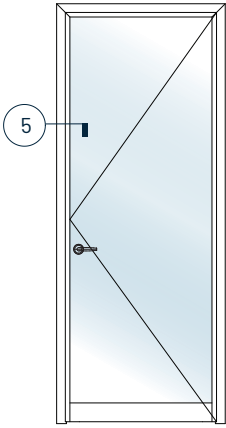

5:5 DETAY
5:5 DETAIL

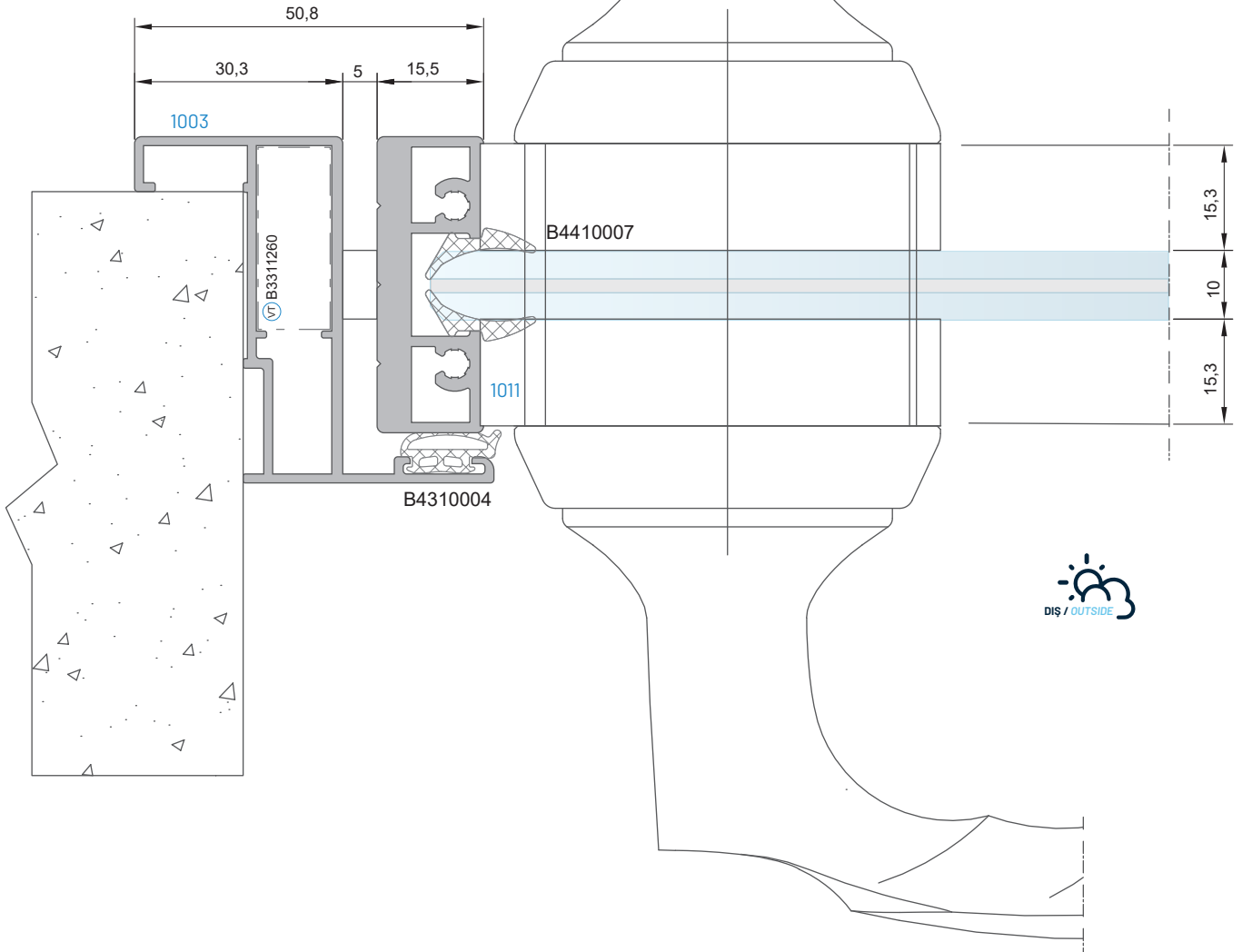

ÖLÇEK: 1:1
SCALE: 1:1

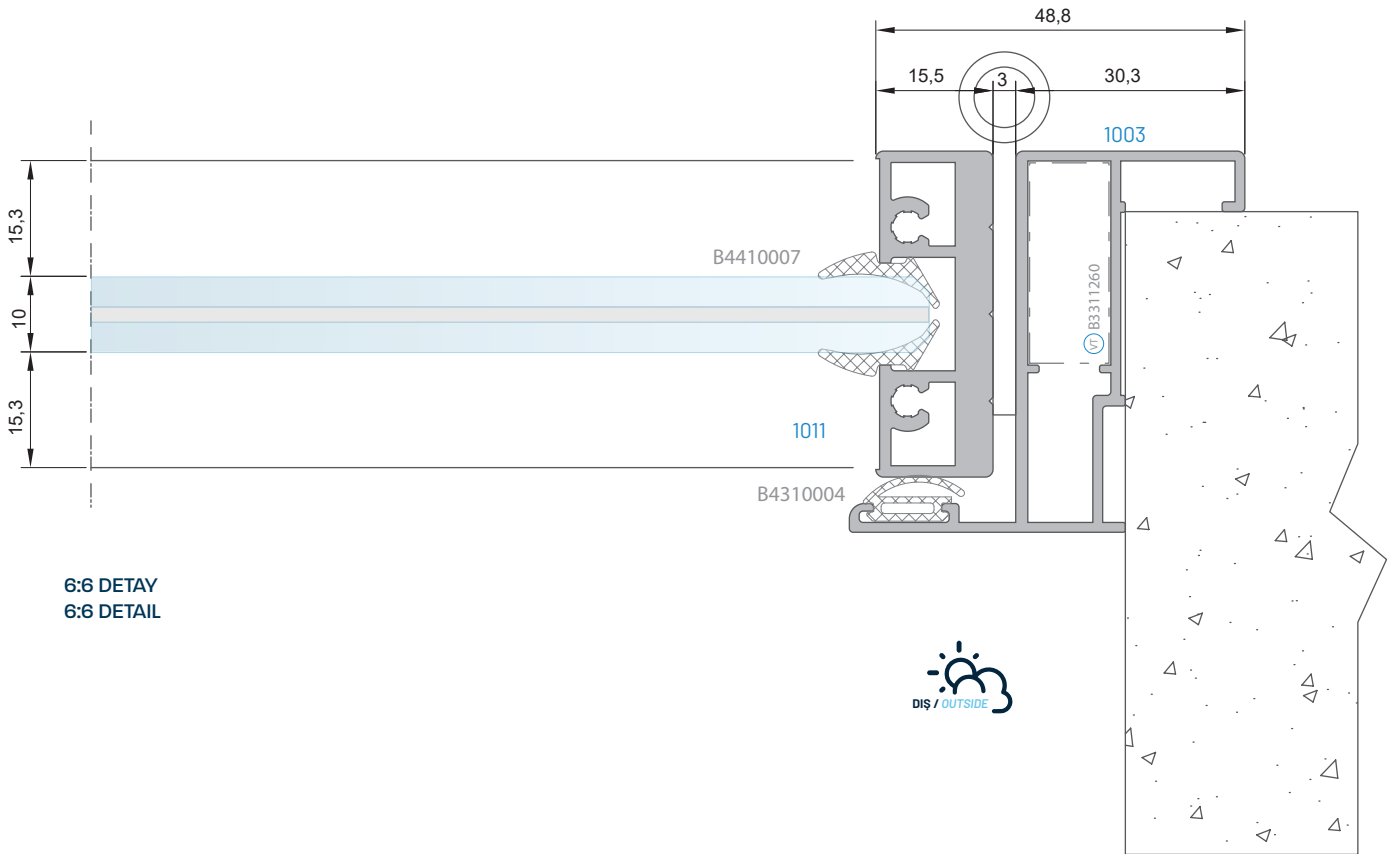
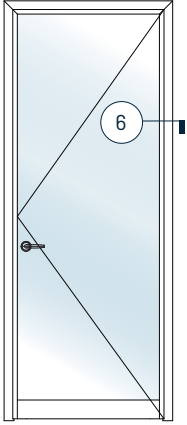

6:6 DETAY
6:6 DETAIL

ÖLÇEK: 1:1
SCALE: 1:1

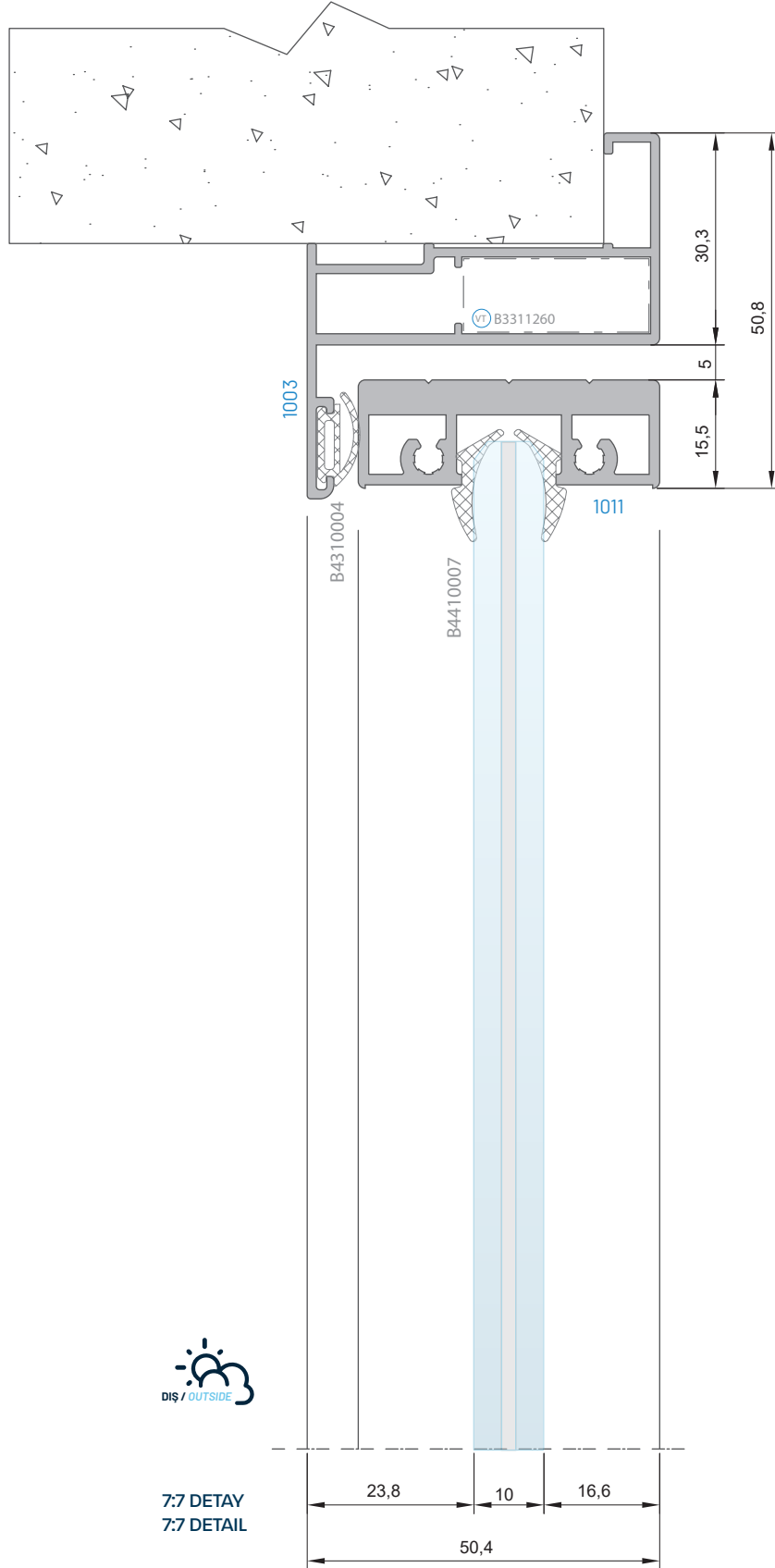
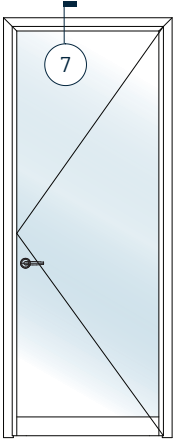

ÖLÇEK: 1:1
SCALE: 1:1

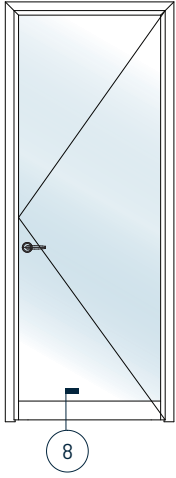

Alt Baza Alternatifleri
Sill Profile Alternatives

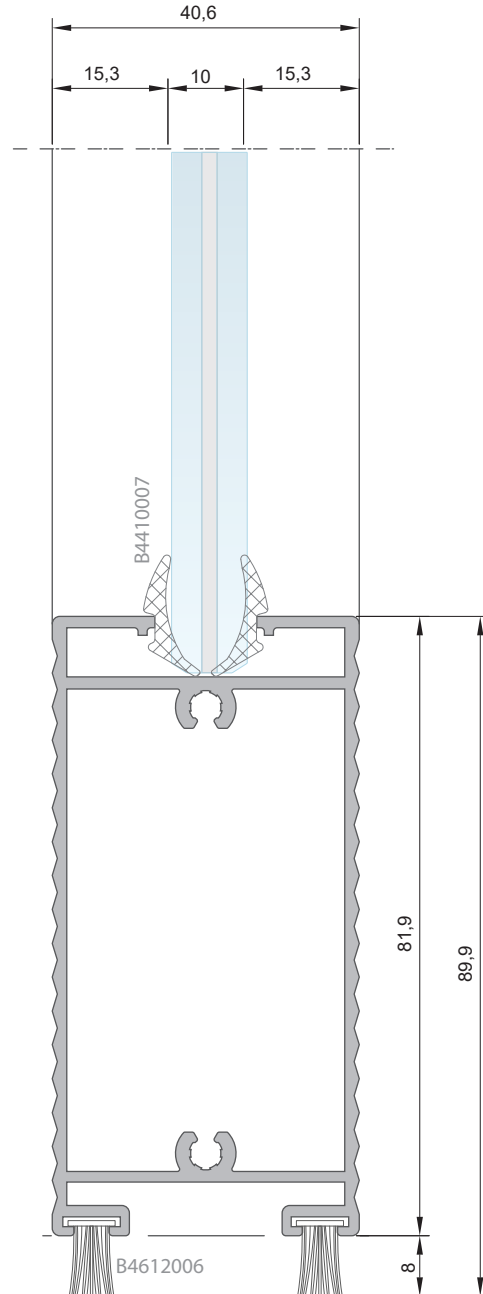
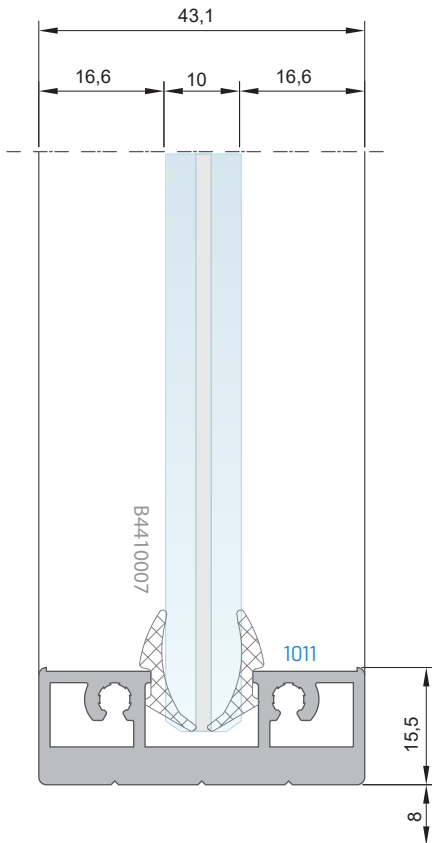

8:8 DETAY
8:8 DETAIL

ÖLÇEK: 1:1
SCALE: 1:1

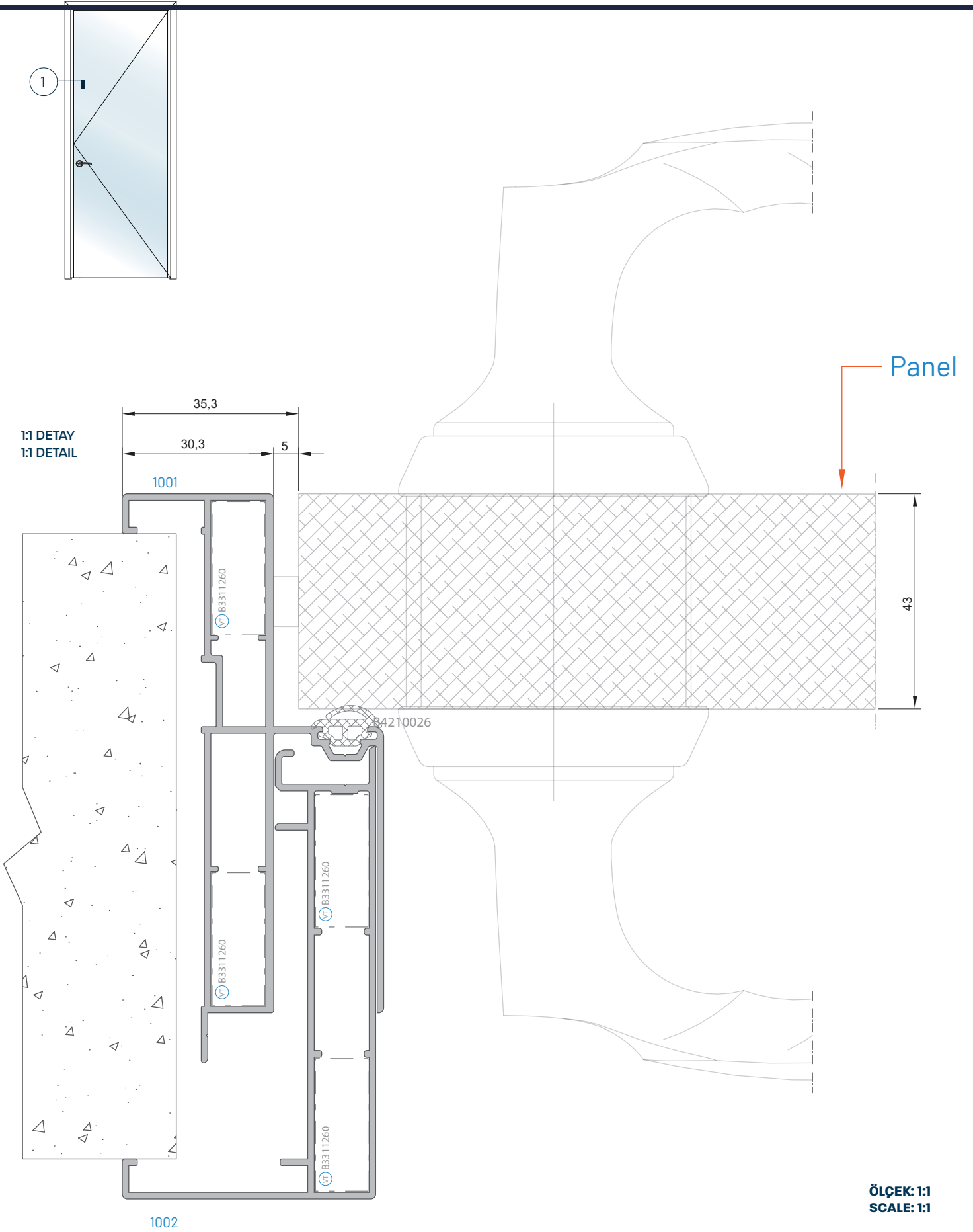

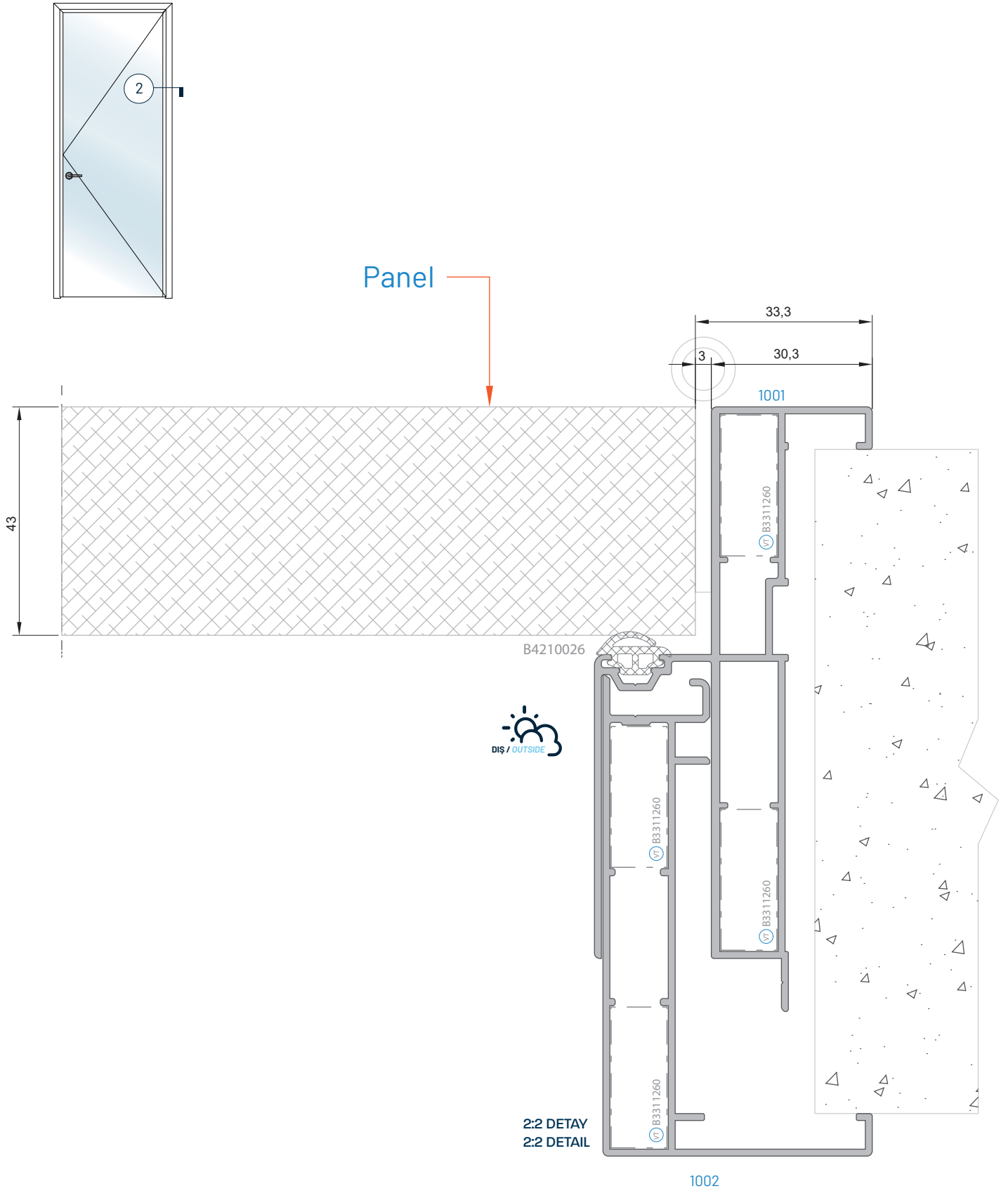

ÖLÇEK: 1:1
SCALE: 1:1

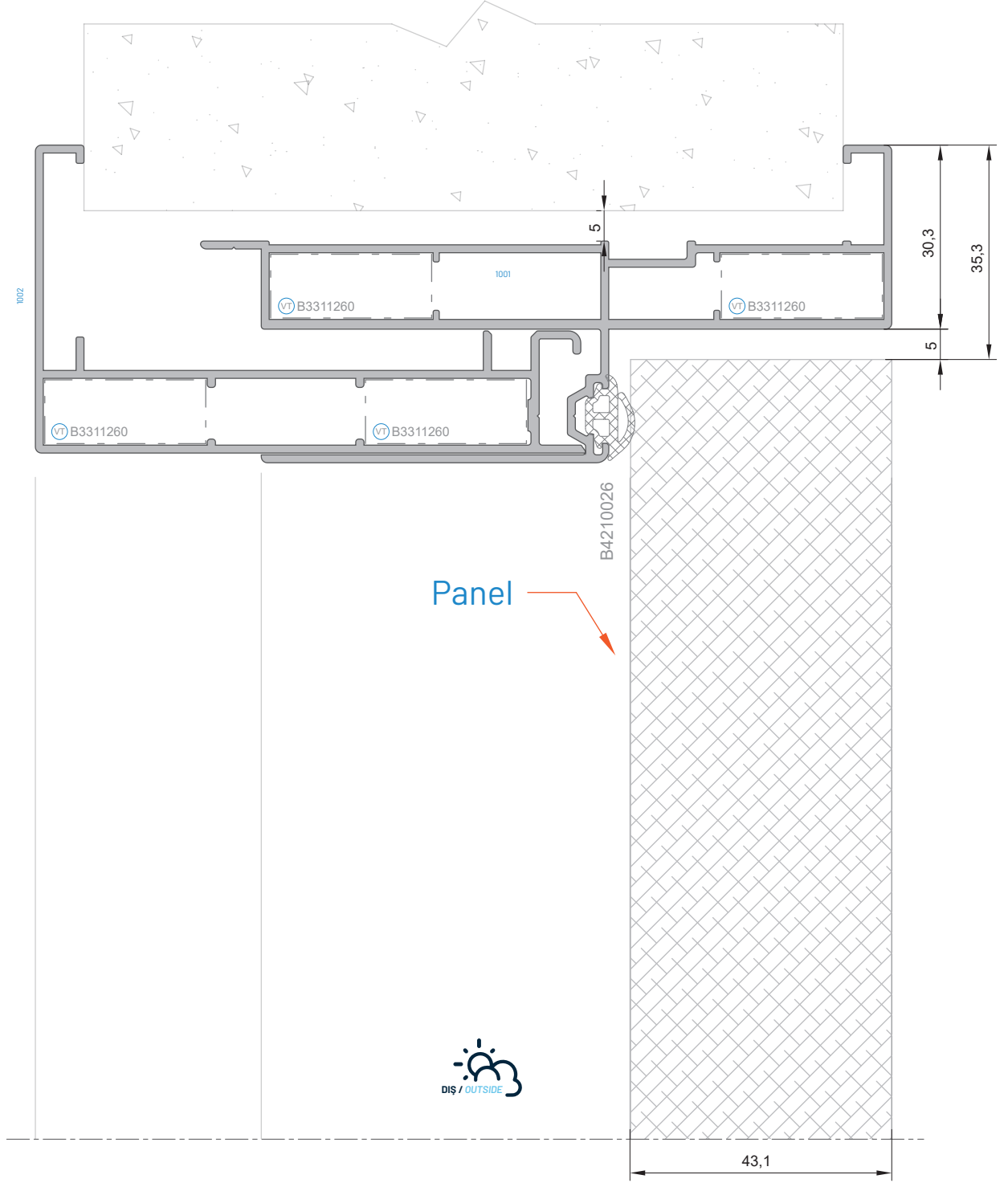
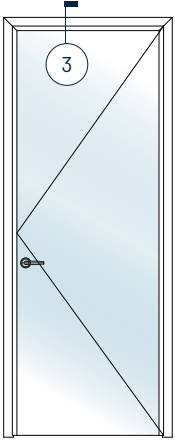

ÖLÇEK: 1:1
SCALE: 1:1

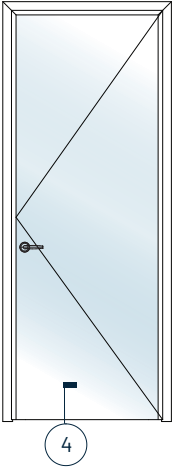

Panel

43

4:4 DETAY
4:4 DETAIL

Zemin
Floor



8

ÖLÇEK: 1:1
SCALE: 1:1

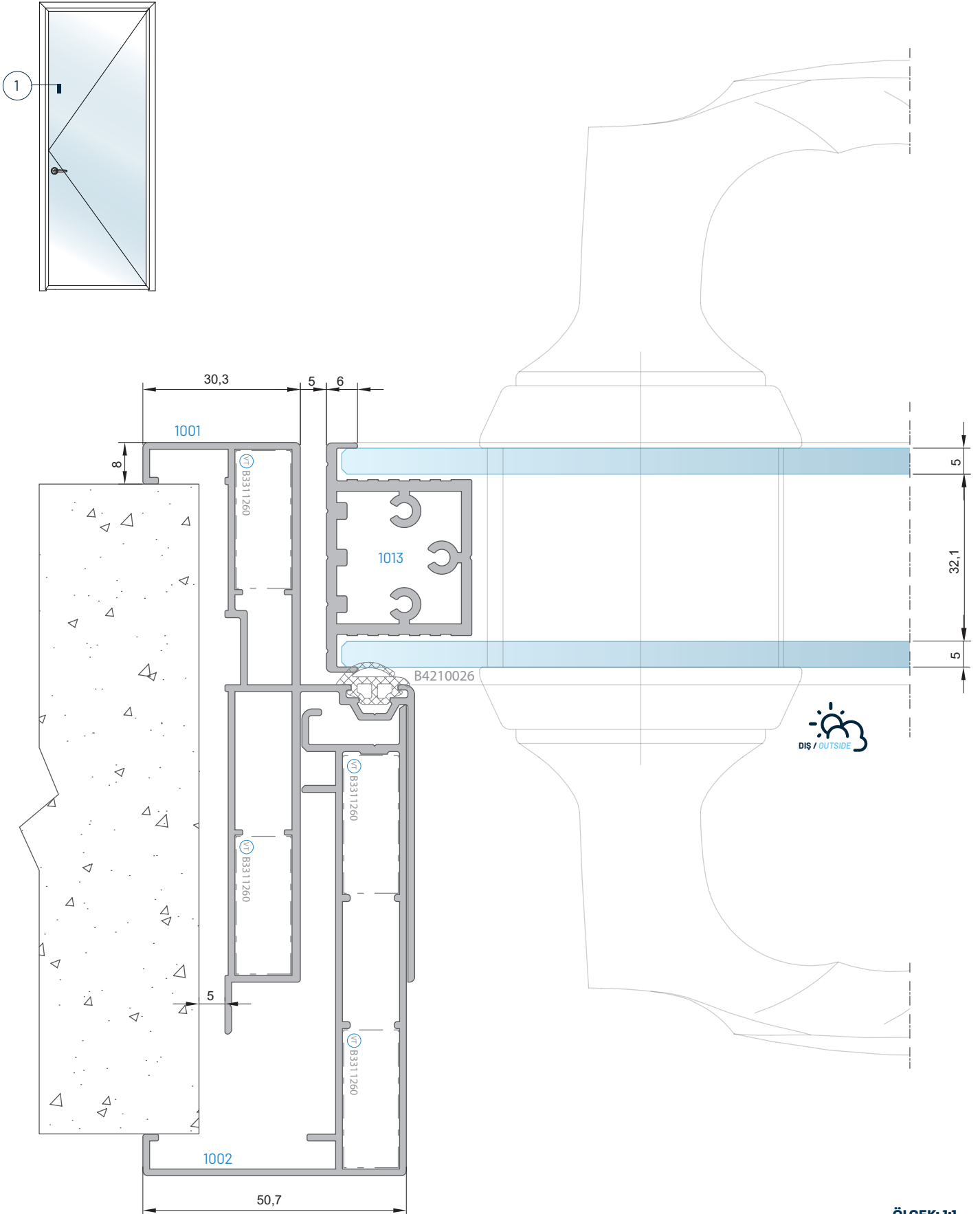

ÖLÇEK: 1:1
SCALE: 1:1

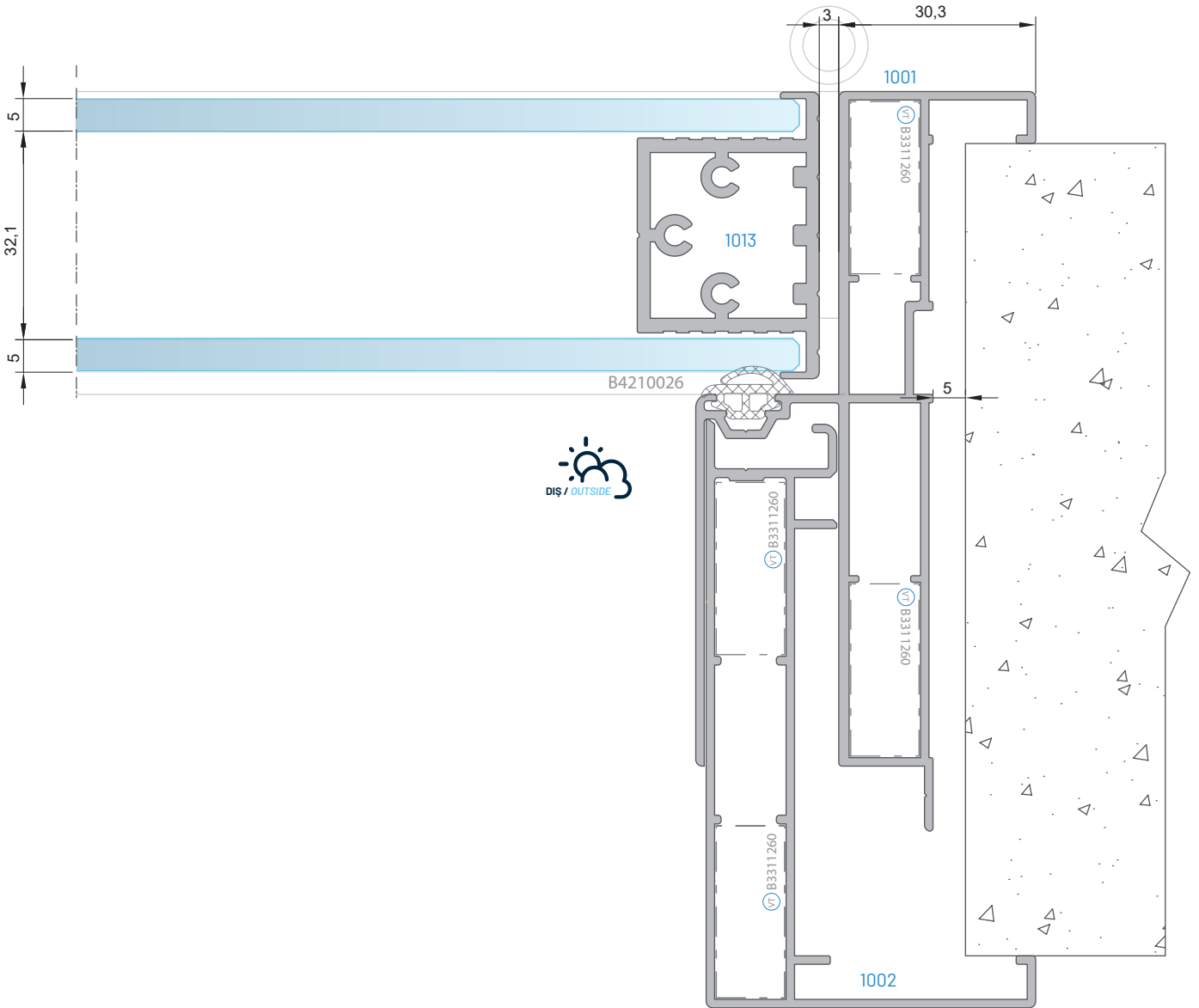
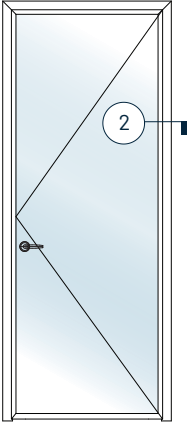

ÖLÇEK: 1:1
SCALE: 1:1

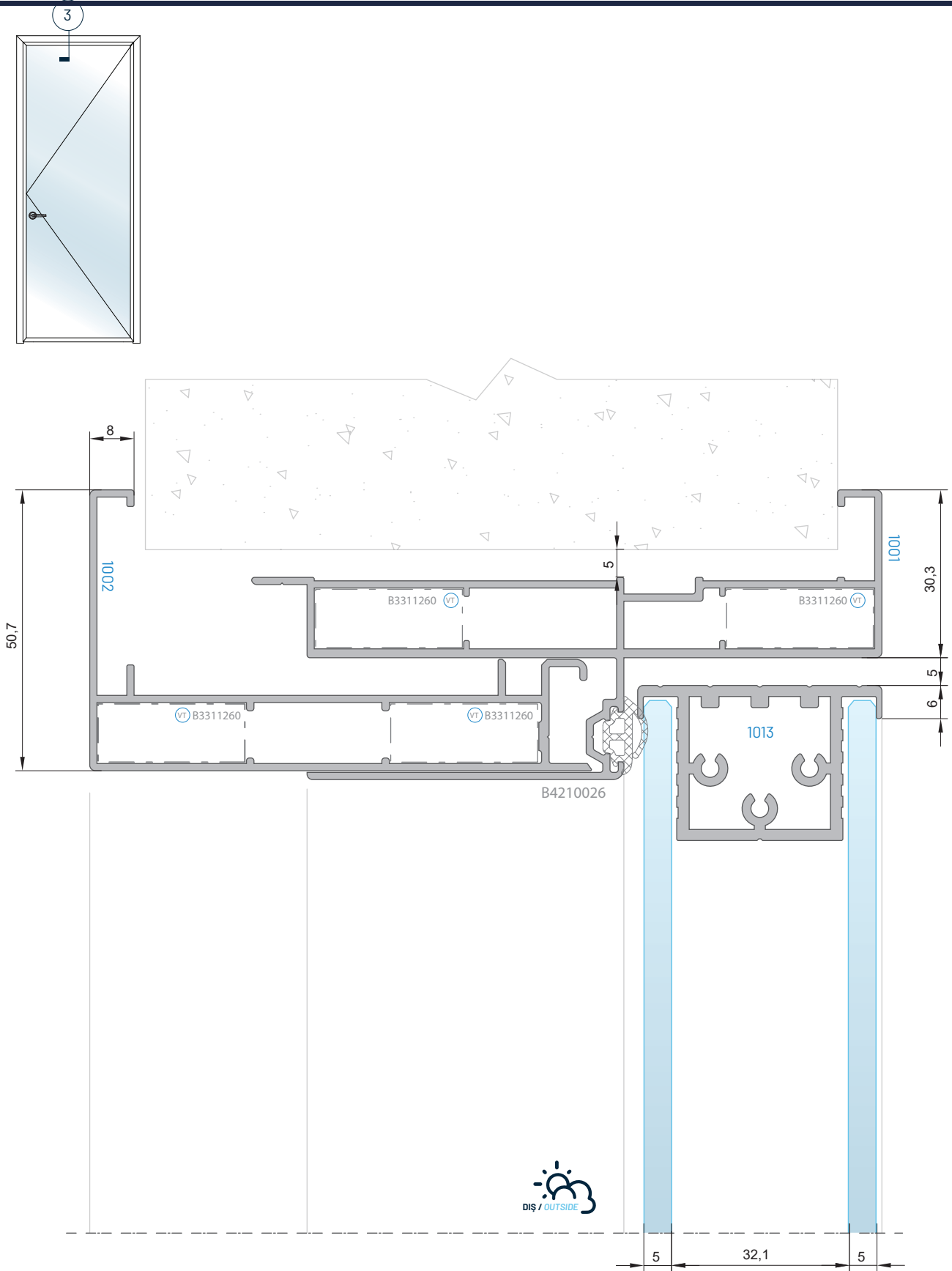

ÖLÇEK: 1:1
SCALE: 1:1

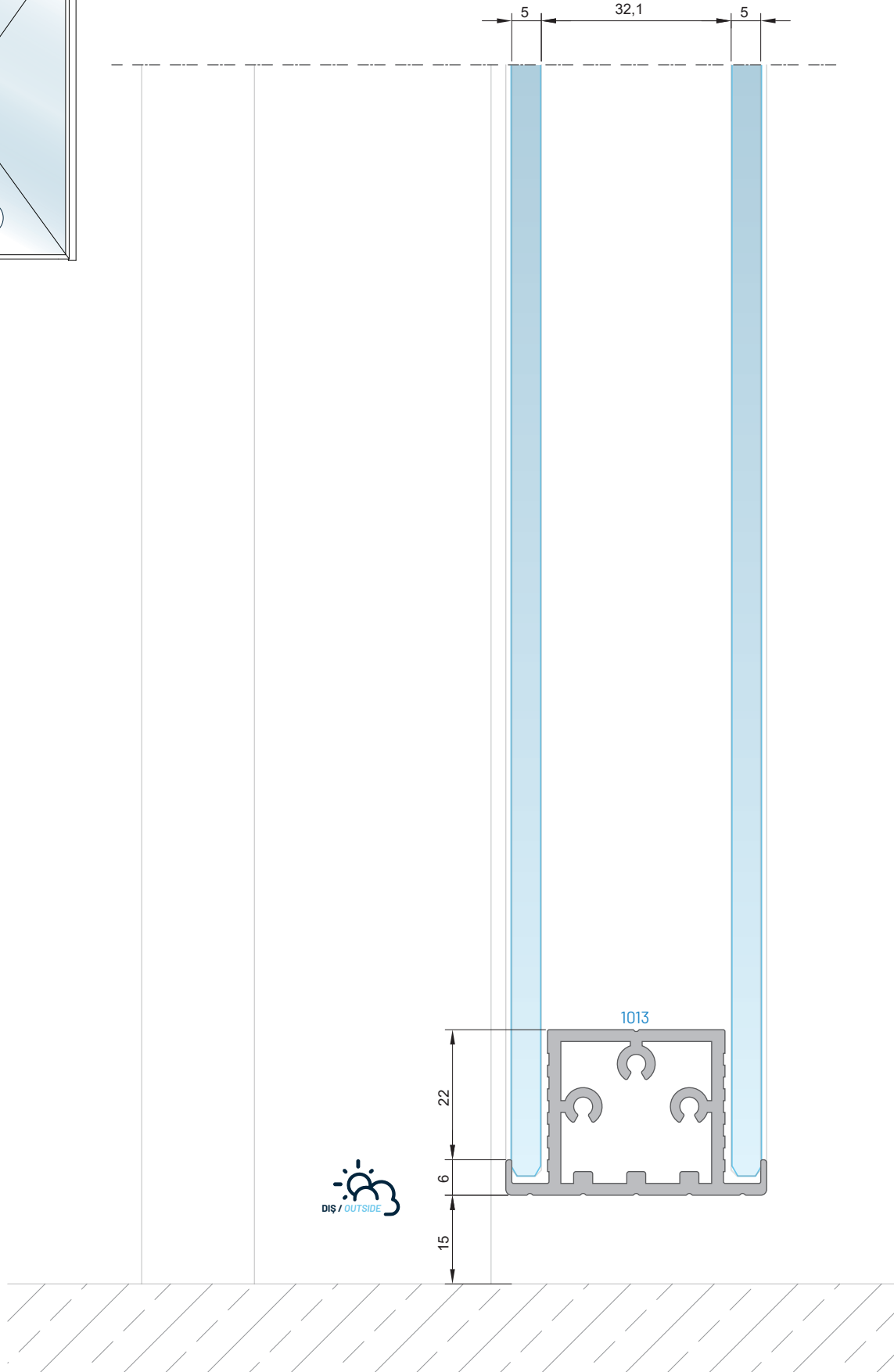
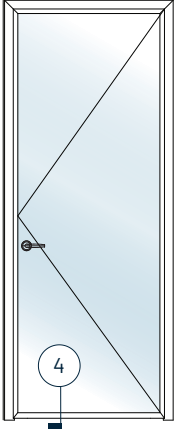

ÖLÇEK: 1:1
SCALE: 1:1

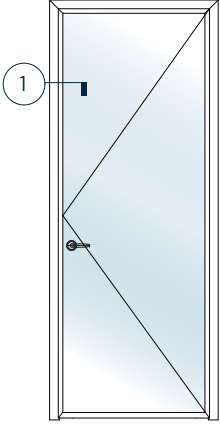

Dış Görünüş / Exterior View

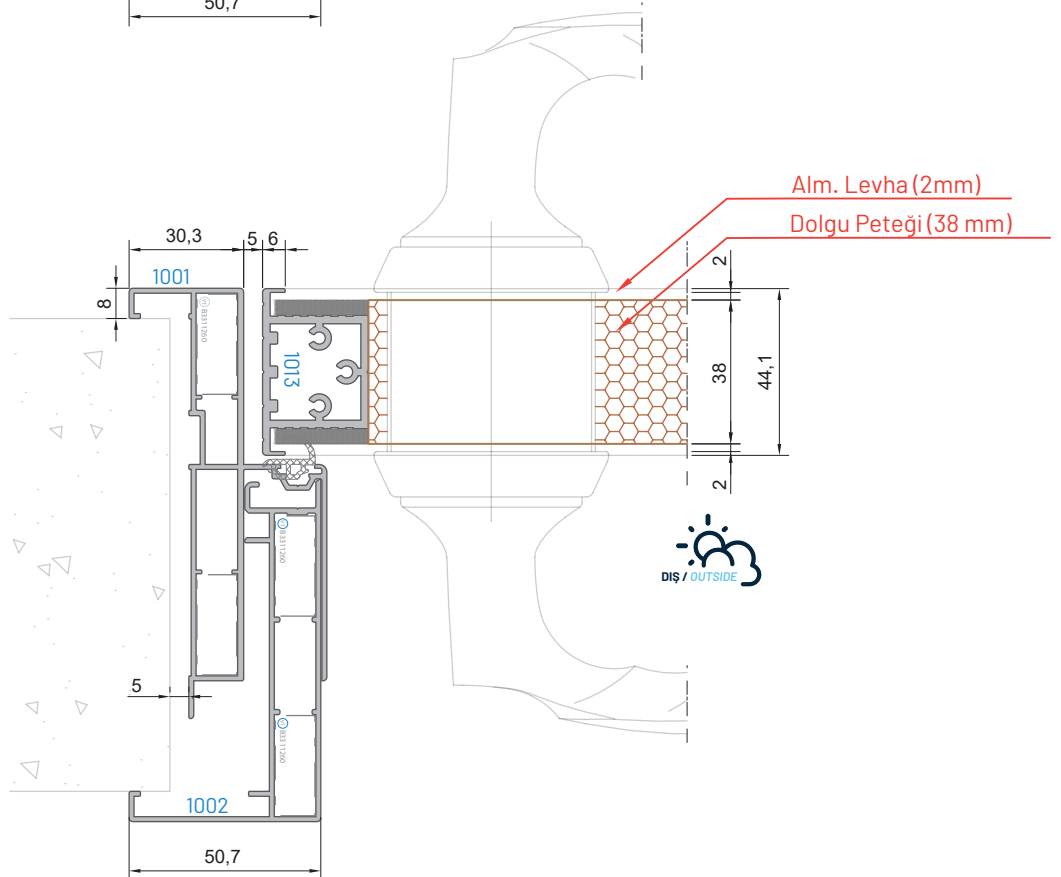
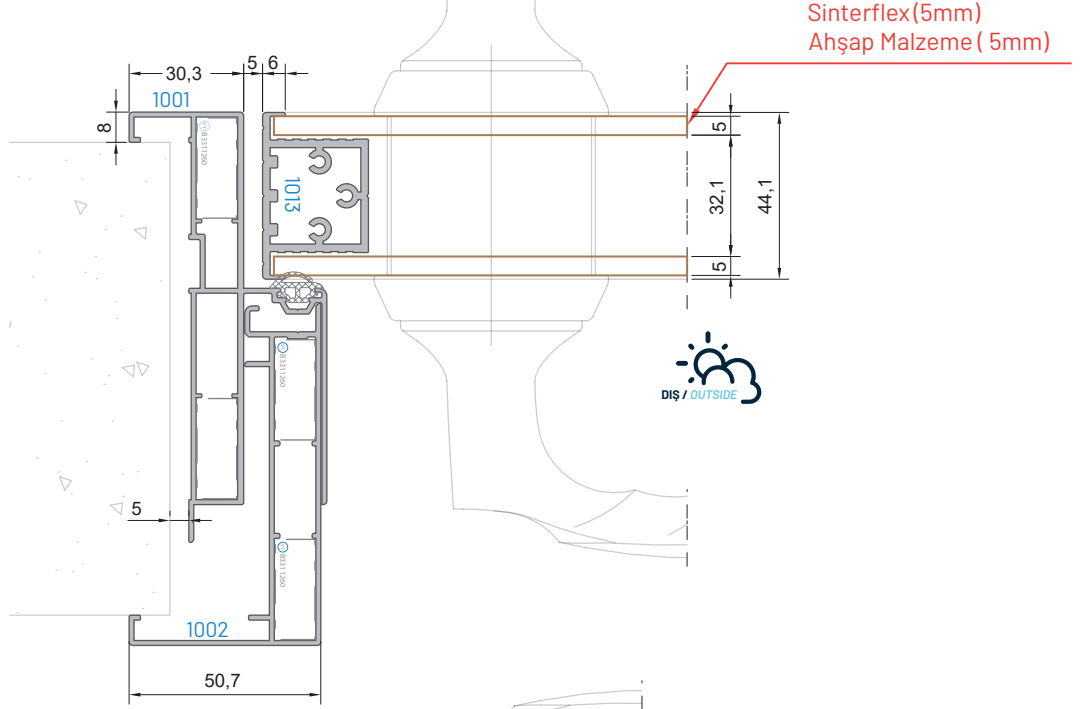
1-1 Detay Opsiyonları
1-1 Details OptionsÖLÇEK: 1:2
SCALE: 1:2

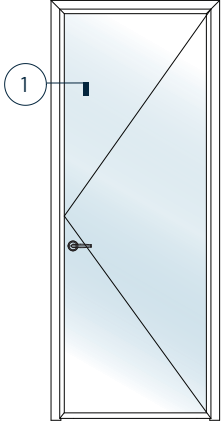

Dış Görünüş / Exterior View

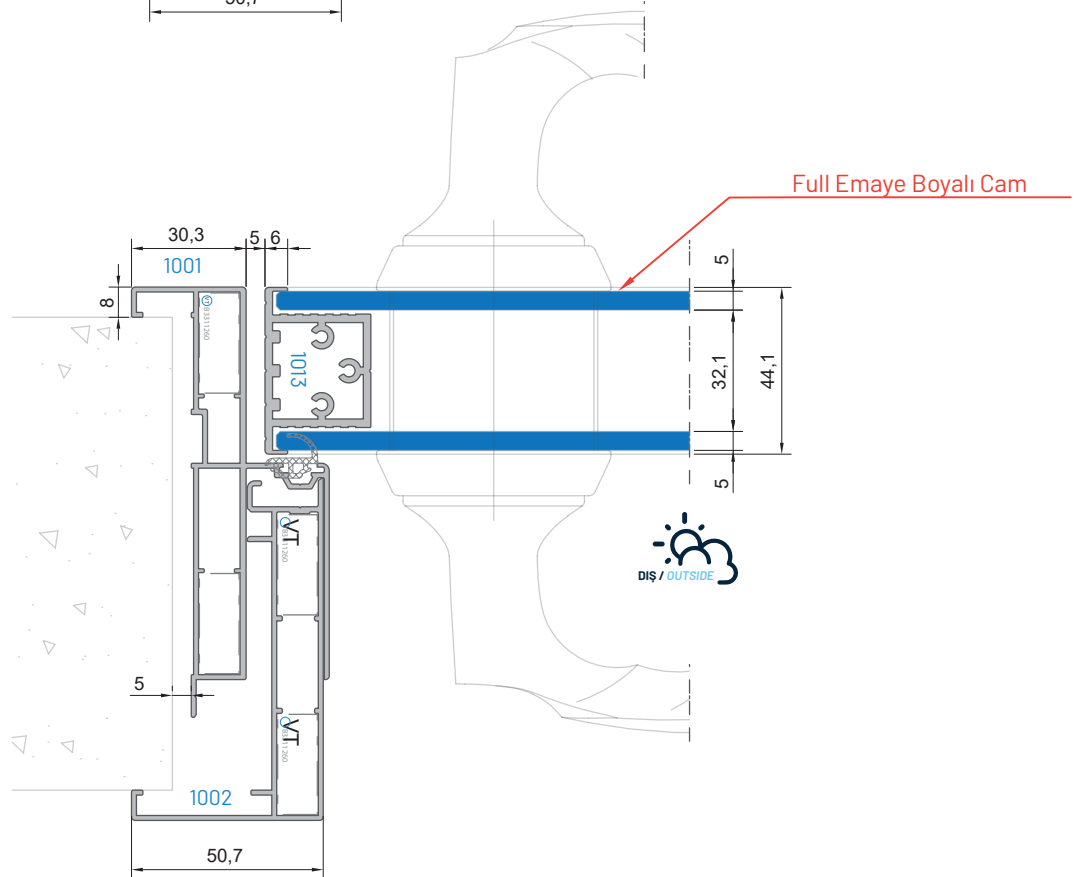
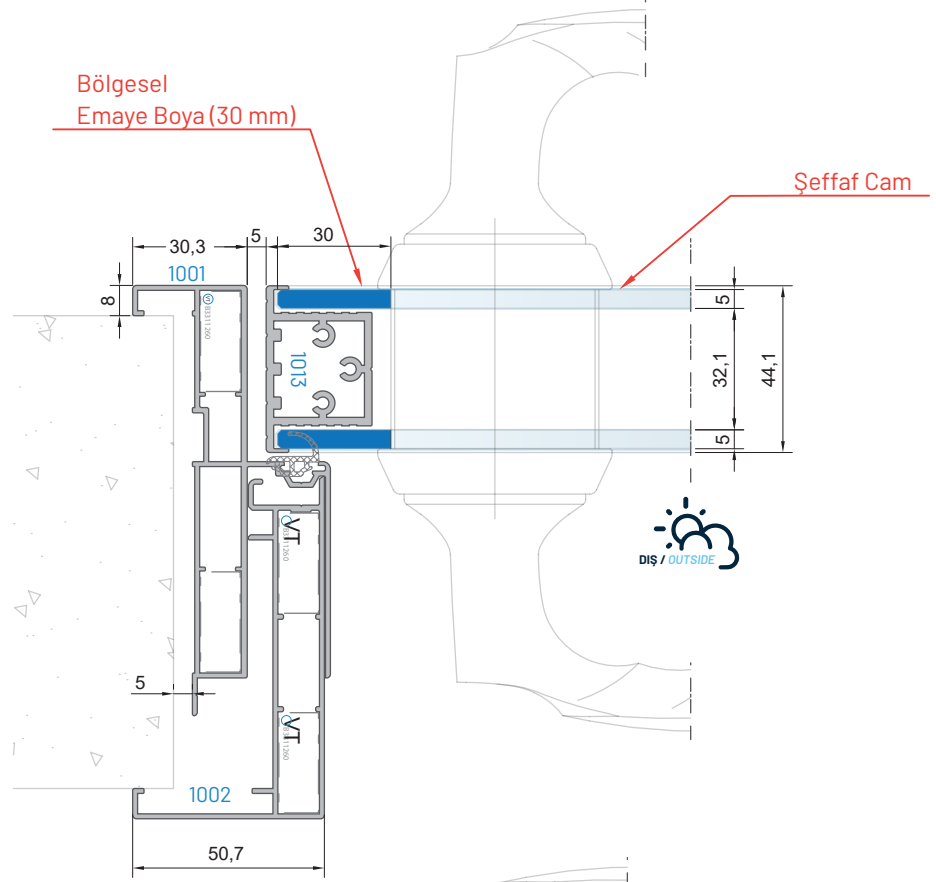
ÖLÇEK: 1:2
SCALE: 1:2

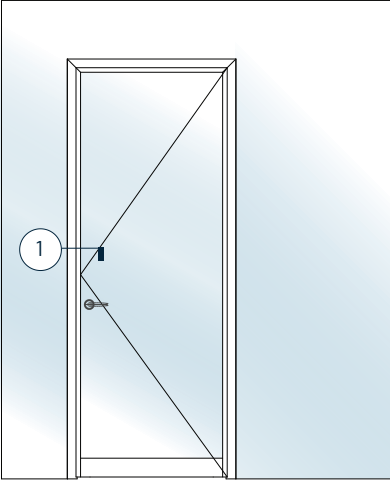
**Cam Duvar**

Cam Kapı Birleşimi Detayları

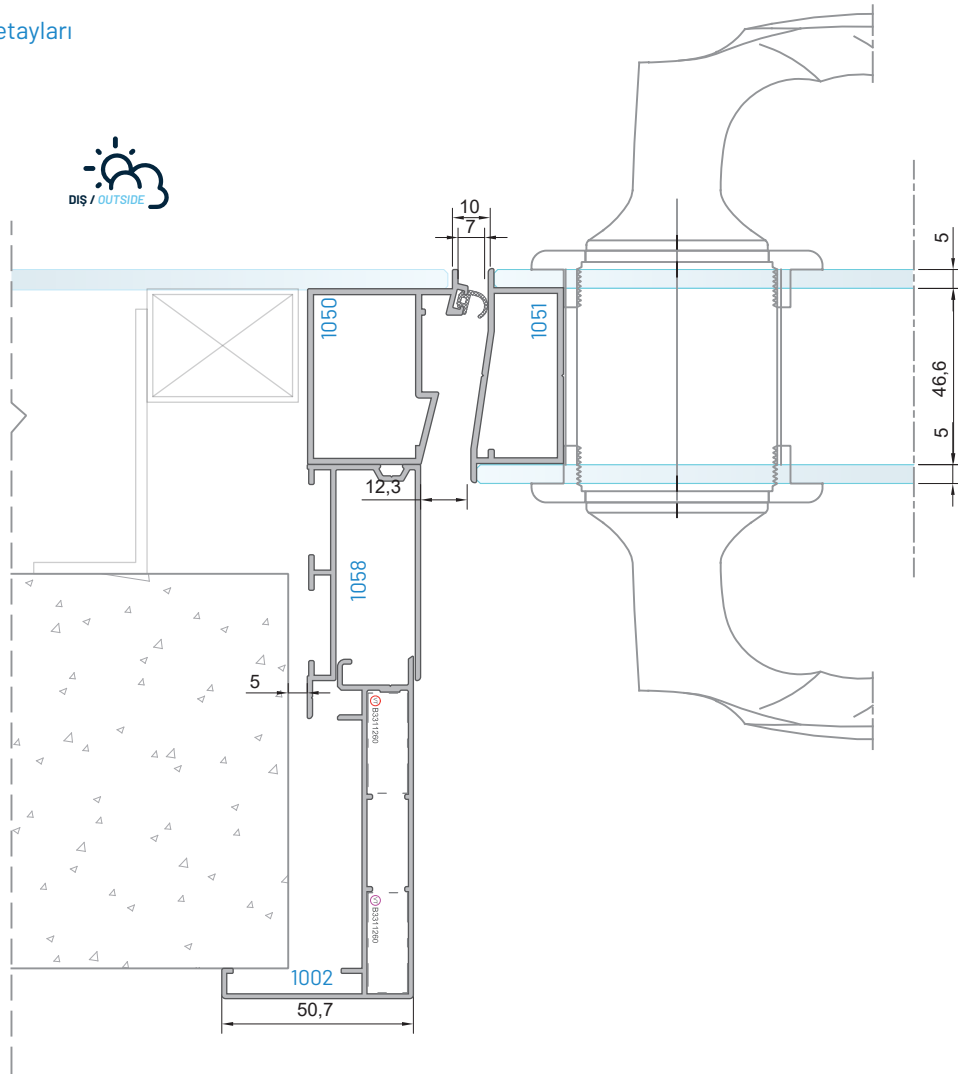
ÖLÇEK: 1:2
SCALE: 1:2

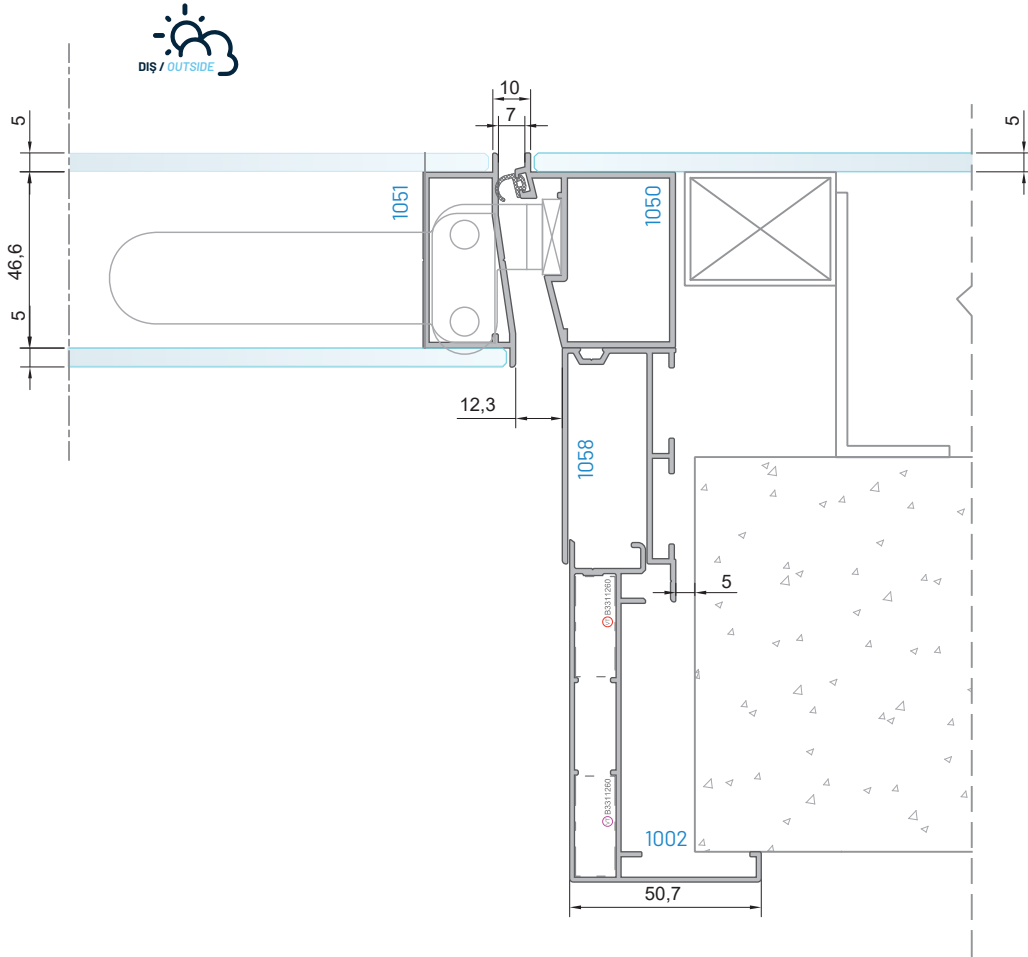
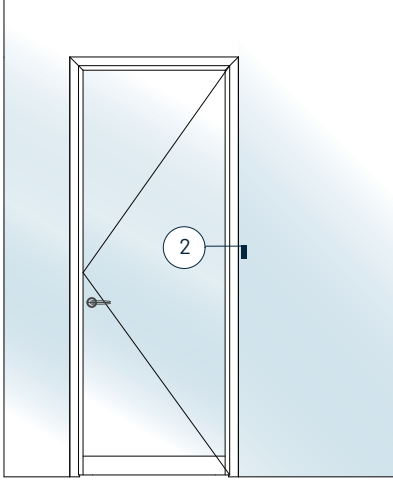

ÖLÇEK: 1:2
SCALE: 1:2

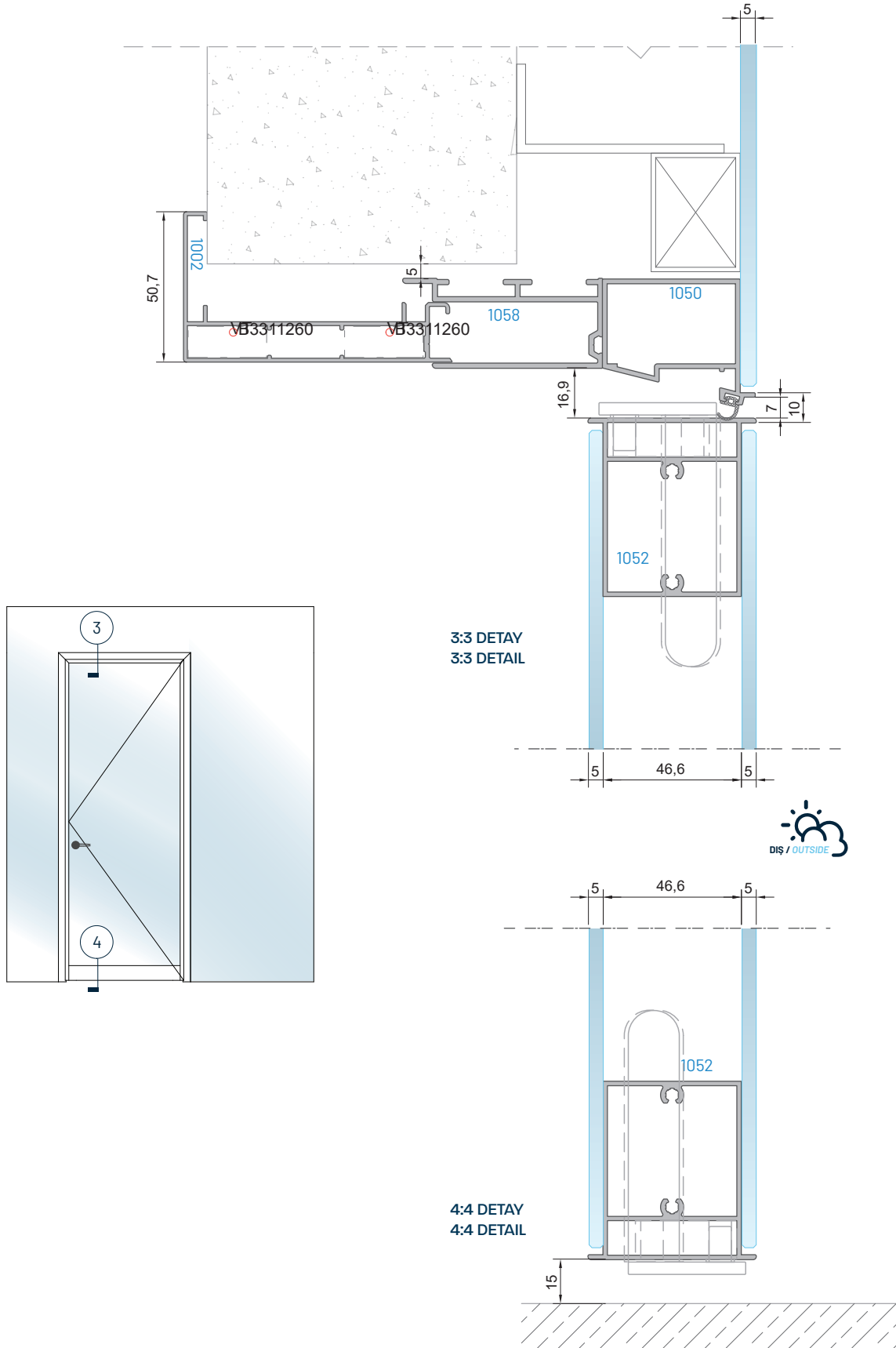

ÖLÇEK: 1:2
SCALE: 1:2